



OPERATING MANUAL (CE)

ROUGH TERRAIN SCISSORS

MODELS **SJ8831 RT** **SJ8841 RT** **SJ9241 RT** **SJ9250 RT**

171007AHA July 2018

SKYJACK

This manual is based on Serial Numbers:

SJRT 8831 36 000 297 & Above
SJRT 8841 40 001 481 & Above
SJRT 9241 55 000 098 & Above
SJRT 9250 50 001 321 & Above (Including 50 001 302 - 50 001 307)

Please refer to the website (www.skyjack.com) for older Serial Numbers.

Skyjack Service Center

3451 Swenson Ave. St. Charles,
Illinois, 60174 USA
Phone: 630-262-0005
Toll Free: 1-800-275-9522
Fax: 630-262-0006
Email: service@skyjack.com

Parts (North America)

Toll Free: 1-800-965-4626
Toll Free Fax: 1-888-782-4825
E-mail: parts@skyjack.com

Skyjack Australia Pty Ltd.

Unit 1, 35 Honeycomb Drive
Eastern Creek
New South Wales 2766
Australia
Tel: +61 (0) 2 9854 0700
Fax: +61 (0) 2 9854 0777

Parts & Service (Europe)

Unit 1 Maes Y Clawdd
Maesbury Road Industrial Estate
Oswestry, Shropshire SY10 8NN UK
Phone: +44-1691-676-235
Fax: +44-1691-676-238
E-mail: info@skyjackeurope.co.uk

Skyjack Brasil

Alameda Júpter, 710
Loteamento American Park Empresarial
Indaiatuba, SP, Brasil 13347-653
Tel: +55 19 3936 0132

The Safety Alert Symbol identifies important safety messages on aerial platform, safety signs in manuals or elsewhere. When you see this symbol, be alert to the possibility of personal injury or death. Follow the instructions in the safety message.



This Safety Alert Symbol means attention!

Become alert! Your safety is involved.



DANGER

DANGER indicates an imminently hazardous situation which, if not avoided, will result in death or serious injury.



WARNING

WARNING indicates a potentially hazardous situation which, if not avoided, could result in death or serious injury.



CAUTION

CAUTION indicates a potentially hazardous situation which, if not avoided, may result in minor or moderate injury. It may also be used to alert against unsafe practices.

IMPORTANT

IMPORTANT indicates a procedure essential for safe operation and which, if not followed, may result in a malfunction or damage to the aerial platform.

Original instructions in English.

Table of Contents

Section 1 - About Your Aerial Platform	5
Read and Heed	5
Safety Rules.....	6
Section 2 - Familiarization	11
2.1 Familiarization of SJRT Mid Size and Full Size Series	11
2.2 Component Identification	12
2.3 Visual & Daily Maintenance Inspections	16
2.4 Function Tests.....	26
2.5 Winching and Towing Procedure	36
2.6 Emergency Lowering Procedures.....	37
Section 3 - Operation	39
3.1 General	39
3.2 Major Components	40
3.3 Major Assemblies	41
3.4 Serial Number Nameplate	41
3.5 Component Identification	42
3.6 Component Identification (Optional Equipment/Attachments).....	44
3.7 Operator's Responsibility	45
3.8 Start Operation	46
3.9 Refueling Procedure	53
3.10 Loading/Unloading	54
3.11 Guardrail Folding Procedure	56
3.12 Maintenance Support Procedure	58
Section 4 - Tables	59
Table 4.1 Standard and Optional Features	59
Table 4.2 Owner's Annual Inspection Record.....	60
Table 4.3 Specifications and Features.....	61
Table 4.4 Maximum Platform Capacities (Evenly Distributed).....	62
Table 4.5 Floor Loading Pressure.....	63
Table 4.6 Tire Specifications	65
Table 4.7 Maintenance and Inspection Schedule	66
Table 4.8 Operator's Checklist.....	67
Section 5 - Labels	69
Section 6 - Skyjack Features	85

SKYJACK is continuously improving and expanding product features on its equipment, therefore, specifications and dimensions are subject to change without notice.

Aerial Platform and Mobile Elevating Work Platform Definition

A mobile device that has a positionable platform supported from ground level by a structure.

Purpose of Equipment

The SKYJACK Rough Terrain's mid and full size aerial platforms are designed to transport and raise personnel, tools and materials to overhead work areas.

Use of Equipment

The aerial platform is a highly maneuverable, mobile work station. Work platform elevation and elevated driving must only be done on a firm, level surface. It can be driven over uneven terrain only when the platform is fully lowered.

Manual

The operating manual is considered a fundamental part of the aerial platform. It is a very important way to communicate necessary safety information to users and operators. A complete and legible copy of this manual must be kept in the provided weather-resistant storage compartment on the aerial platform at all times.

Operator

The operator must read and completely understand both this operating manual and the safety panel label located on the platform and all other warnings in this manual and on the aerial platform. Compare the labels on the aerial platform with the labels found within this manual. If any labels are damaged or missing, replace them immediately.

Service Policy and Warranty

SKYJACK warrants each new SJRT Series aerial platform to be free of defective parts and workmanship for the first 24 months. Any defective part will be replaced or repaired by your local SKYJACK dealer at no charge for parts or labor. Contact the SKYJACK Service Department for warranty statement extensions or exclusions.

Optional Accessories

The SKYJACK aerial platform is designed to accept a variety of optional accessories. These are listed under "Standard and Optional Features" in [Table 4.1](#). Operating instructions for these options (if equipped) are located in [Section 3](#) of this manual.

For non-standard components or systems, contact the SKYJACK Service Department at

☎ : 44-1691-676-235

✉ : 44-1691-676-238

Include the model and serial number for each applicable aerial platform.

Scope of this Manual

a. This manual applies to the CE version of the Rough Terrain's mid and full size aerial platform models listed on [Table 4.1](#).

- Equipment identified with "CE" meets the requirements for the European countries, i.e., Machinery Directive 2006/42/EC and/or Directive 2000/14/EC and the corresponding EN standards.

b. Operators are required to conform to national, state or territorial/provincial and local health and safety regulations applicable to the operation of this aerial platform.

 **WARNING**

Failure to comply with your required responsibilities in the use and operation of the aerial platform could result in death or serious injury!

Operator Safety Reminders

A study conducted by St. Paul Travelers showed that most accidents are caused by the failure of the operator to follow simple and fundamental safety rules and precautions.

You, as a careful operator, are the best insurance against an accident. Therefore, proper usage of this aerial platform is mandatory. The following pages of this manual should be read and understood completely before operating the aerial platform.

Common sense dictates the use of protective clothing when working on or near machinery. Use appropriate safety devices to protect your eyes, ears, hands, feet and body.

Any modifications from the original design are strictly forbidden without written permission from SKYJACK.

Electrocution Hazard

This aerial platform is not electrically insulated. Maintain a Minimum Safe Approach Distance (MSAD) from energized power lines and parts as listed below. The operator **must allow** for the platform to sway, rock or sag. **This aerial platform does not provide protection from contact with or proximity to an electrically charged conductor.**

**DO NOT USE THE AERIAL PLATFORM AS A GROUND FOR WELDING.
DO NOT OPERATE THE AERIAL PLATFORM DURING LIGHTNING OR STORMS.
DO NOT OPERATE THE AERIAL PLATFORM NEAR POWER LINES. MAINTAIN A MINIMUM SAFE APPROACH DISTANCE (MSAD) FROM ENERGIZED POWER LINES.**



DANGER

Avoid Power Lines

Minimum Safe Approach Distance

CE Guidance Note

“Avoidance of danger from overhead lines”

Adhere strictly to the governmental rulings and regulations applicable in your country.

FAILURE TO AVOID THIS HAZARD WILL RESULT IN DEATH OR SERIOUS INJURY!

Safety Precautions

Know and understand the safety precautions before going on to next section.



WARNING

Failure to heed the following safety precautions could result in tip over, falling, crushing, or other hazards leading to death or serious injury.

- **KNOW** all national, state or territorial/provincial and local rules which apply to your aerial platform and jobsite.
- **TURN** main power disconnect switch “○” off when leaving the aerial platform unattended. Remove the key to prevent unauthorized use of the aerial platform.

- **WEAR** all the protective clothing and personal safety devices issued to you or called for by job conditions.

- **DO NOT** wear loose clothing, dangling neckties, scarves, rings, wristwatches or other jewelry while operating this lift.



- **AVOID** entanglement with ropes, cords or hoses.



- **AVOID** falling. Stay within the boundaries of the guardrails.



- **DO NOT** raise the aerial platform or operate elevated in windy or gusty conditions that exceed the limits specified in [Section 4, Table 4.4](#).



- **DO NOT** increase the lateral surface area of the platform. Increasing the area exposed to the wind will decrease aerial platform stability. Avoid tenting.



- **DO NOT** elevate or drive elevated on a slope. Elevated driving must be done on a firm, level surface.



- **DO NOT** drive elevated on a soft or uneven surface.



- **DO NOT** elevate the aerial platform if it is not on a firm, level surface.

- **DO NOT** drive elevated near depressions or holes of any type, loading docks, debris, drop-offs or surfaces that may affect the stability of the aerial platform.



- **IF OPERATION IN AREAS WITH HOLES OR DROP-OFFS IS ABSOLUTELY NECESSARY**, elevated driving shall not be allowed. Position the aerial platform horizontally only with the platform fully-lowered. After ensuring that all 4 wheels or outriggers (if equipped) have contact with a firm, level surface, the aerial platform can be elevated. After elevation, the drive function must not be activated.



- **DO NOT** ascend or descend a grade when elevated. When fully-lowered, ascend or descend grades up to maximum rated inclines listed in [Table 4.3](#).



Safety Precautions (Continued)

Know and understand the safety precautions before going on to next section.

- **DO NOT** operate on surfaces not capable of holding the weight of the aerial platform including the rated load, e.g. covers, drains, and trenches.

- **DO NOT** operate an aerial platform that has ladders, scaffolding or other devices mounted on it to increase its size or work height. It is prohibited.



- **DO NOT** exert side forces on aerial platform while elevated.



- **DO NOT** use the aerial platform as a crane. It is prohibited.



- **DO NOT** sit, stand or climb on the guardrails. It is prohibited.



- **DO NOT** climb on scissor arm assembly. It is prohibited.



- **AVOID** overhead obstructions. Be aware of overhead obstructions or other possible hazards around aerial platform when lifting or driving.



- **AVOID** crushing hazards. Be aware of crushing hazards when lifting or driving. Keep all body parts inside the aerial platform.



- **DO NOT** raise the aerial platform while the aerial platform is on a truck, fork lift or other device or vehicle.



- **DO NOT** lower the platform unless the area below is clear of personnel and obstructions.



- **ENSURE** that there are no personnel or obstructions in the path of travel, including blind spots.



- **BE AWARE** of blind spots when operating the aerial platform.

- **DO NOT** use with improperly inflated/damaged tires or wheels. Refer to [Section 2: Wheel/Tire Assembly](#).



- **ENSURE** ALL tires are in good condition and lug nuts are properly tightened.

- **DO NOT** alter or disable limit switches or other safety devices.



Safety Precautions (Continued)

Know and understand the safety precautions before going on to next section.

- **DO NOT** use the aerial platform without guardrails, locking pins and the entry gate(s) in place.



- **DO NOT** attempt to free a snagged platform with lower controls until personnel are removed from the platform.

- **DO NOT** use under influence of alcohol or drugs.



- **DO NOT** position the aerial platform against another object to steady the platform.

- **STUNT** driving and horseplay are prohibited.

- **DO NOT** exceed the rated capacity of the aerial platform.



- **DO NOT** place materials on the guardrails or materials that exceed the confines of the guardrails unless approved by Skyjack.

- **DO NOT** distribute load unevenly.



- **DO NOT** operate if aerial platform is not working properly or if any parts are damaged or worn.



- **DO NOT** leave aerial platform unattended with key in key switch.



Safety Precautions (Continued)

Know and understand the safety precautions before going on to next section.

Fall Protection

The guardrail system provides fall protection for the occupants. If additional fall protection is required, by an employer or the authority having jurisdiction, Skyjack recommends the use of a fall restraint system to keep an occupant within the confines of the platform, and thus not expose the occupant to any fall hazard requiring a fall arrest. When used, lanyards should only be attached to dedicated attachment points on the platform.

All personal fall protection equipment must comply with applicable governmental regulations and must be inspected and used in accordance with the manufacturer's recommendations.

All personal fall protection equipment must be attached only to approved anchorage points within the platform.



WARNING

Entering and exiting the aerial platform should only be done using the three points of contact.

- **Use only equipped access openings.**
- **Enter and exit only when the aerial platform is in the fully retracted position.**
- Do use three points of contact to enter and exit the platform. Enter and exit the platform from the ground only. Face the aerial platform when entering or exiting the platform.
- Three points of contact means that two hands and one foot or one hand and two feet are in contact with the aerial platform or the ground at all times during entering and exiting.



WARNING

An operator should not use any aerial platform that:

- **does not appear to be working properly.**
- **has been damaged or appears to have worn or missing parts.**
- **has alterations or modifications not approved by the manufacturer.**
- **has safety devices which have been altered or disabled.**
- **has been tagged or locked out for non-use or repair.**

Failure to avoid these hazards could result in death or serious injury.

Jobsite Inspection

- Do not use in hazardous locations.
- Perform a thorough jobsite inspection prior to operating the aerial platform, to identify potential hazards in your work area.
- Be aware of moving equipment in the area. Take appropriate actions to avoid collision.

2.1 Familiarization of SJRT Mid Size and Full Size Series



WARNING

Aerial Platform Familiarization should be given only to individuals who are QUALIFIED And TRAINED to operate an aerial platform.

Do not operate this aerial platform without proper authorization and training. Failure to avoid this hazard could result in death or serious injury.

It is the responsibility of the operator to read, completely understand and follow all instructions and warnings contained in this operating manual and on the aerial platform.

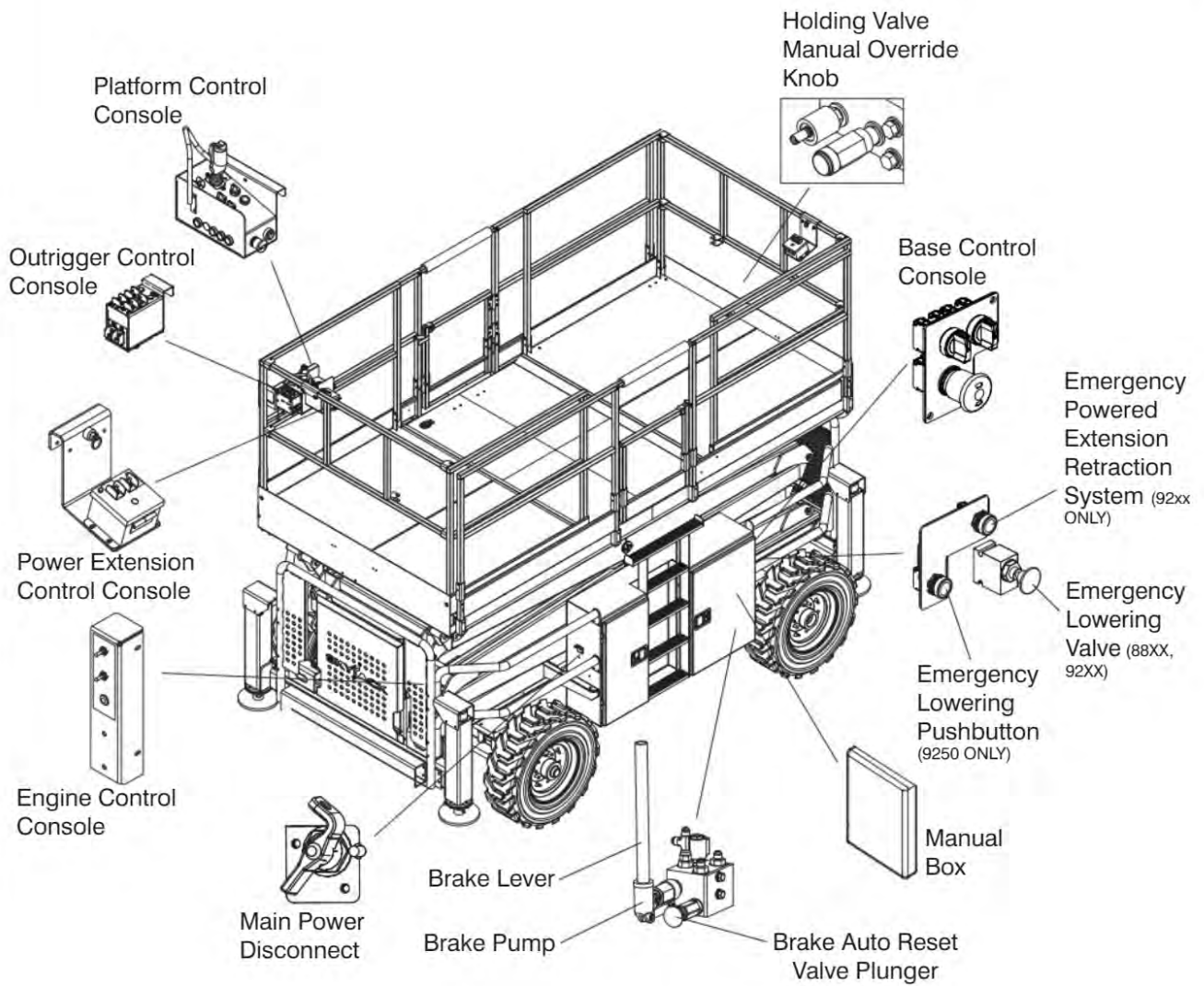

FAMILIARIZATION

2.2 Component Identification

The following descriptions are for identification, explanation and locating purposes only.

2.2-1 Main Power Disconnect Switch

This switch is located at the side of the hydraulic/ electrical compartment.

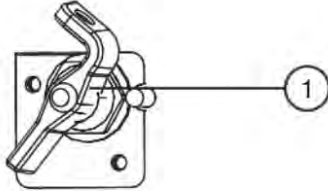

Figure 2-1. Main Power Disconnect Switch

1. **Main Power Disconnect Switch** - This switch, when in “○” off position, disconnects power to all circuits. Switch must be in “|” on position to operate any circuit. Turn switch off when transporting aerial platform.

2.2-2 Motion Alarm

The alarm produces an audible sound when any control function is selected. On aerial platforms with certain options, a flashing amber light will accompany this alarm.

2.2-3 Tilt Alarm

The aerial platform is equipped with a device which senses when the aerial platform is out of level in any direction. When activated, it disables drive and lift functions of the aerial platform and an alarm produces an audible sound accompanied by the amber light. If the alarm sounds, lower the platform completely, then reposition aerial platform so that it is level before raising the platform.

NOTE

If the tilt alarm sounds and the platform does not, or only partially raises, immediately lower the platform completely and ensure that the aerial platform is on a firm level surface.

2.2-4 Load Sensing System

This system is a safety device that prevents any normal movement of the aerial platform from a stationary working condition after the rated load is reached and exceeded. Refer to [Table 4.4](#) for maximum platform capacities.

- **When 90% of the rated load is reached:**
The red power indicator light on the platform control console flashes.
- **When the rated load is reached:**
An audible alarm sounds for approximately 2 seconds, 5 times per minute.
- **When the rated load is exceeded:**
The flashing light and audible alarm continue and all electrically controlled aerial platform movement functions stop. To resume normal operation, remove the overload from the platform.
- **If the aerial platform during the operation comes in contact with an overhead obstruction:**
The platform could become overloaded and all functions would stop. Release of the platform from this situation can only be effected by use of the emergency lowering system. Refer to [Section 2.6](#).

NOTE

After reaching full extension and upon lowering, the aerial platform could stop and take an overload reading. Return the proportional controller to the neutral center position, and release the enable trigger switch. If the aerial platform is overloaded, the flashing light and audible alarm continue and all electrically controlled aerial platform movement functions stop. To resume normal operation, remove the overload from the platform.

2.2-5 Base Control Console

This control console is located at the rear of the hydraulic/electrical compartment. It contains the following controls:

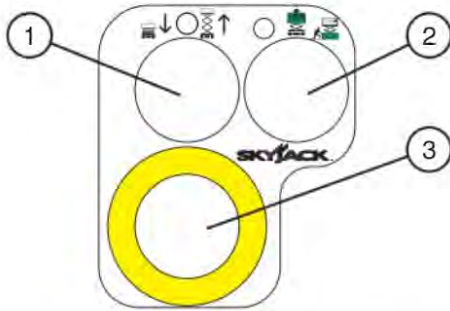

Figure 2-2. Base Control Console

1. **Lower/Neutral/Raise Switch** - This switch controls “ ” raising or “ ” lowering of platform.
2. **Off/Platform/Base Key Switch** - This three-way switch allows the operator to turn “ ” off power to aerial platform or to activate either “ ” platform or “ ” base controls.
3. **Emergency Stop Button** - This button “ ”, when depressed, disconnects power to the control circuit.

2.2-6 Brake System

The brake system is located on the main manifold in the hydraulic/electrical compartment. The brake must be manually disengaged before pushing, winching or towing. Refer to [Section 2.5](#) for procedure on how to release the brake manually. The system contains the following controls:

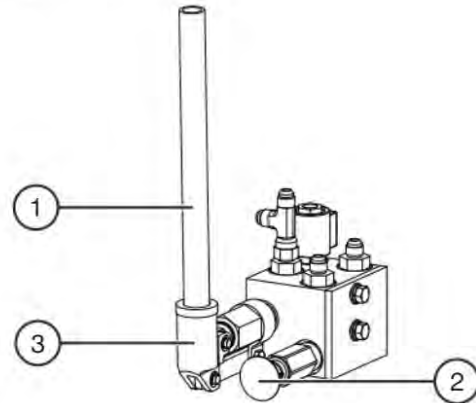

Figure 2-3. Brake System

1. Brake Lever
2. Brake Auto Reset Valve Plunger
3. Brake Pump

2.2-7 Emergency Powered Extension Platform Retraction System (Model 9250)

This system is located in the hydraulic/electrical compartment. In the event of an emergency or an engine malfunction, this switch (item 1) can retract the powered extension platform from the base. Refer to [Section 3.8-8](#) for emergency retraction procedure.

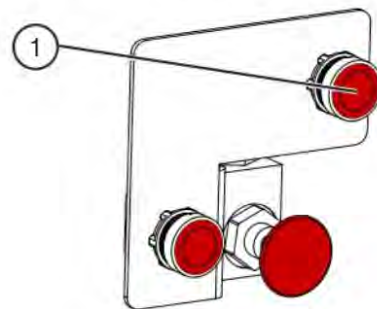

Figure 2-4. Emergency Powered Extension Platform Retraction System

2.2-8 Emergency Lowering System

This emergency lowering system allows platform lowering in the event of an emergency or an electrical system failure. Refer to [Section 2.6](#) for the emergency lowering procedures. The system contains the following controls:

Models 88xx & 9241

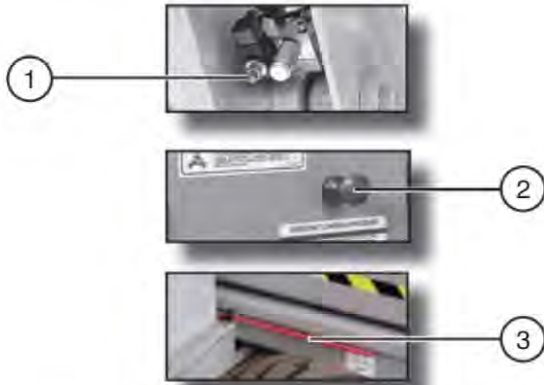

Figure 2-5. Emergency Lowering System

1. **Holding Valve Manual Override Knob** - Located on the holding valve at the bottom of each lift cylinder.
2. **Emergency Lowering Valve** - Located at the rear of the hydraulic/electrical compartment.
3. **Emergency Lowering Access Rod** - Located either at the base, on top of scissor guards, or on top of fuel cabinet.

Model 9250

This emergency lowering system is located on the hydraulic tank and is accessed through a hole in the hydraulic/electrical compartment door.

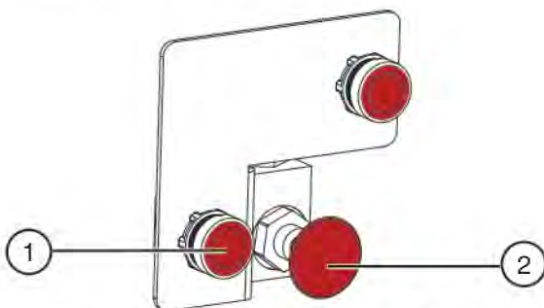

Figure 2-6. Emergency Lowering System

1. Emergency Lowering Pushbutton
2. Emergency Lowering Valve

2.2-9 Lowering Warning System

A lowering warning system automatically stops the lowering function before reaching the fully retracted position and sounds the alarm.

2.2-10 Engine Control Console

This control console is attached to the engine tray. It contains the following controls:

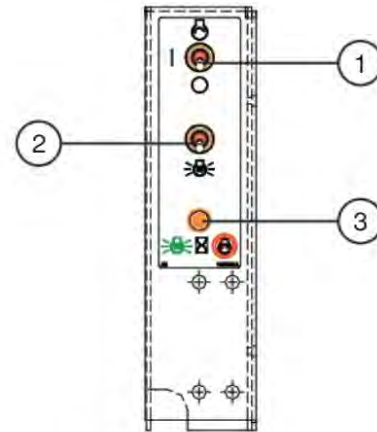

Figure 2-7. Engine Control Console - Diesel Engine

1. **Engine Off/On/Start Switch** - This is a three-position switch. When in "I" on position, it energizes engine circuit. When in "⏻" start position, it starts the engine (switch will return to on position when released). When in "O" off position, it turns engine off.
2. **Glow Plug Switch** - This "⚡" momentary toggle switch energizes the glow plugs to aid in starting a cold diesel engine. Glow plugs are only active while switch is activated.
3. **Glow Plug Indicator Light** - This red lamp illuminates until the glow plugs have completed the timed heating cycle. When the lamp goes out, the engine is ready to be started.

2.2-11 Platform Control Console

This removable control console is mounted at the right front of the platform. It contains the following controls:

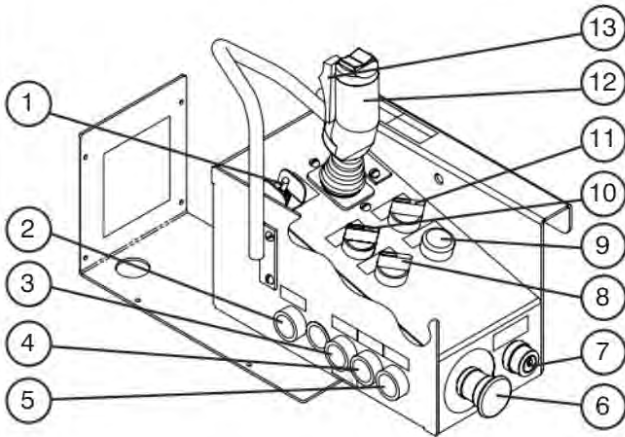

















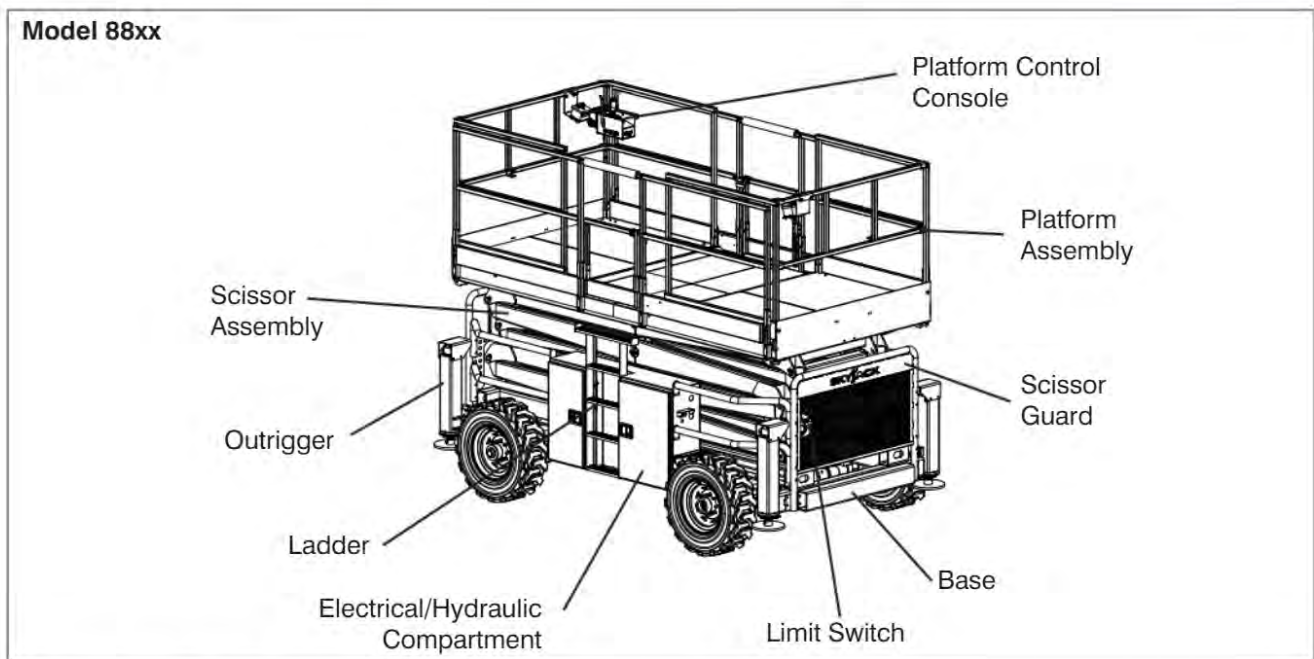

Figure 2-8. Platform Control Console

1. **Torque Switch** - This switch, when in “” high torque position, cuts out high range and 3rd speed to provide maximum torque when climbing grades and on rough terrain. When in “” low torque position, all three speeds are available.
 2. **Horn Pushbutton** - This “” pushbutton sounds an automotive-type horn.
 3. **Glow Plug Pushbutton (Diesel)** - This pushbutton energizes the “” glow plugs to aid in starting a cold diesel engine.
 4. **Engine Start Pushbutton** - This “” pushbutton energizes the engine starter motor.
- NOTE**
- The engine start pushbutton is interlocked with the oil pressure switch. If engine stalls or does not start immediately, this button will not work for a few seconds while oil pressure bleeds off.
5. **Lift Enable Pushbutton** - When depressed and held, this “” pushbutton allows the lift functions to operate.
 6. **Emergency Stop Button** - This button “”, when depressed, disconnects power to control circuit and shuts engine off. The red colored light indicates upper control availability and overload status. When the light is continuously illuminated, upper controls are available. When the light is flashing, it signals an overload function. Refer to [Section 2.2-4](#).
 7. **Off/Lift/Drive Key Switch** - Selecting “” off position disconnects power from both lift and drive circuits. Selecting “” lift position energizes the lift circuit. Selecting “” drive position energizes the drive circuit.
 8. **Raise/Off/Lower Switch** - This switch controls “” raising or “” lowering of the platform.
 9. **Operation Light** - The red colored light indicates upper control availability and overload status. When the light is continuously illuminated, upper controls are available. When the light is flashing, it signals an overload function. Refer to [Section 2.2-4](#).
 10. **Low/High Speed Range Switch** - This switch selects “” low speed range (high torque) or “” high speed range (low torque).
 11. **Low/High Throttle Switch** - This rotary switch allows selection between “” low and “” high engine throttle speeds.
 12. **Drive/Steer Controller** - This one-hand lever controls drive speed and steer motion. Internal springs return it to neutral when controller is released. The rocker switch on top of controller handle controls steering function.
 13. **Drive/Steer Enable Trigger Switch** - This momentary “” switch energizes the controller. It must be held depressed continuously while engaging either drive or steer functions.



2.3 Visual & Daily Maintenance Inspections

Begin the visual and daily maintenance inspections by checking each item in sequence for the conditions listed in this section.



WARNING

To avoid injury, do not operate an aerial platform until all malfunctions have been corrected.



WARNING

To avoid possible injury, ensure aerial platform power is off during your visual and daily maintenance inspections.



CAUTION

Ensure aerial platform is on a firm, level surface.

NOTE

While doing visual and daily inspections in different areas, be aware to also inspect limit switches, electrical and hydraulic components.

2.3-1 Labels

Refer to [Section 5 - Labels](#) in this manual and determine that all labels are in place and are legible.

2.3-2 Electrical

Maintaining the electrical components is essential to good performance and service life of the aerial platform.

Inspect the following areas for chafed, corroded and loose wires:

- base to platform cables and wiring harness
- engine compartment electrical panel
- engine wiring harness
- hydraulic/electrical wiring harnesses

2.3-3 Limit Switches

Ensure limit switches are properly secured with no signs of visible damage and movement is not obstructed.

2.3-4 Hydraulic

Maintaining the hydraulic components is essential to good performance and service life of the aerial platform.

Perform a visual inspection around the following areas:

- hydraulic tank filter, fittings, hoses, emergency power unit (if equipped) and base surfaces
- engine compartment fittings, hoses, main pump, and filter
- all hydraulic cylinders
- all hydraulic manifolds
- the underside of the base
- ground area under the aerial platform
- outriggers



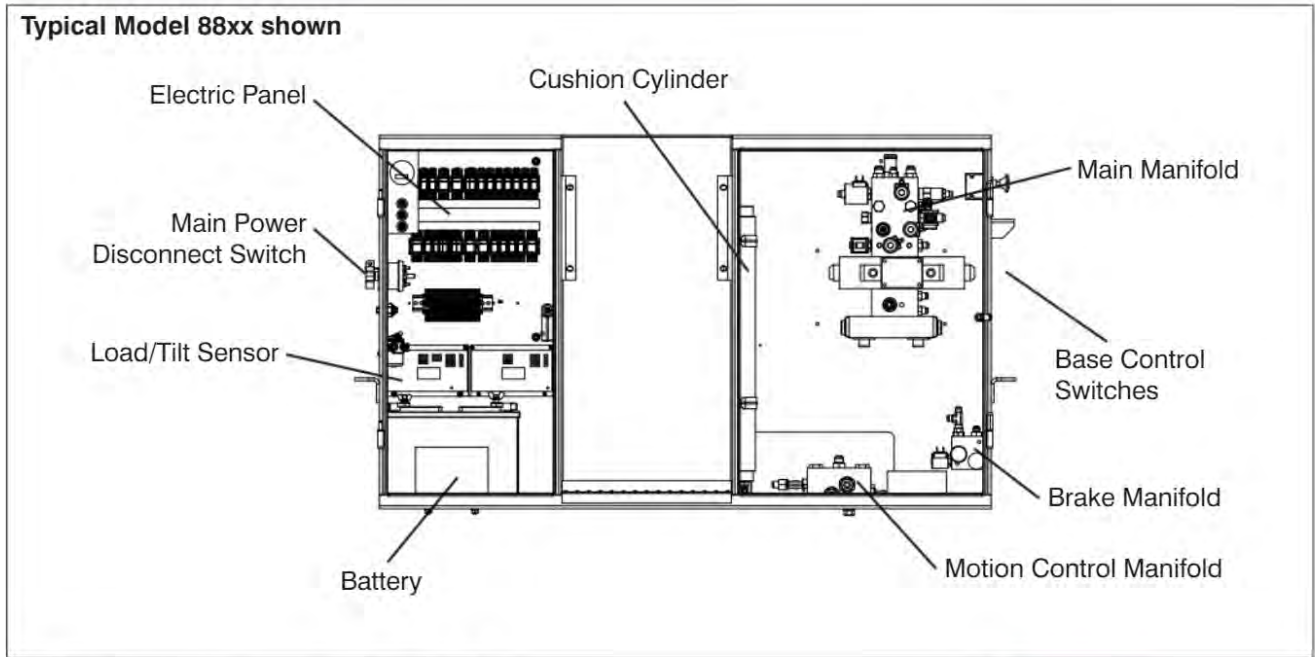

2.3-5 Emergency Lowering Access Rod (All models except 9250)

Ensure rod is properly secured and there is no visible damage.

2.3-6 Hydraulic/Electrical Compartment

- Ensure all compartment latches are secure and in proper working order.
- **Main Power Disconnect Switch**
 - Turn main power disconnect switch to “O” off position.
 - Ensure all cables are secure and switch is in proper working condition.
- **Base Control Switches**
 - Ensure there are no signs of visible damage and all switches are in their neutral positions.
- **Battery**
 Proper battery condition is essential to good performance and operational safety. Improper fluid levels or damaged cables and connections can result in component damage and hazardous conditions.



WARNING
 Battery acid is extremely corrosive - Wear proper eye and facial protection as well as appropriate protective clothing. If contact occurs, immediately flush with cold water and seek medical attention.

1. Check battery case for damage.
2. Clean battery terminals and cable ends thoroughly with a terminal cleaning tool or wire brush.
3. Ensure all battery connections are tight.
4. If applicable, check battery fluid level. If plates are not covered by at least 13 mm of solution, add distilled or demineralized water.
5. Replace battery if damaged or incapable of holding a lasting charge.



WARNING
 Use original or manufacturer-approved parts and components for the aerial platform.



WARNING
 Explosion hazard. Keep flames and sparks away. Do not smoke near batteries.



FAMILIARIZATION

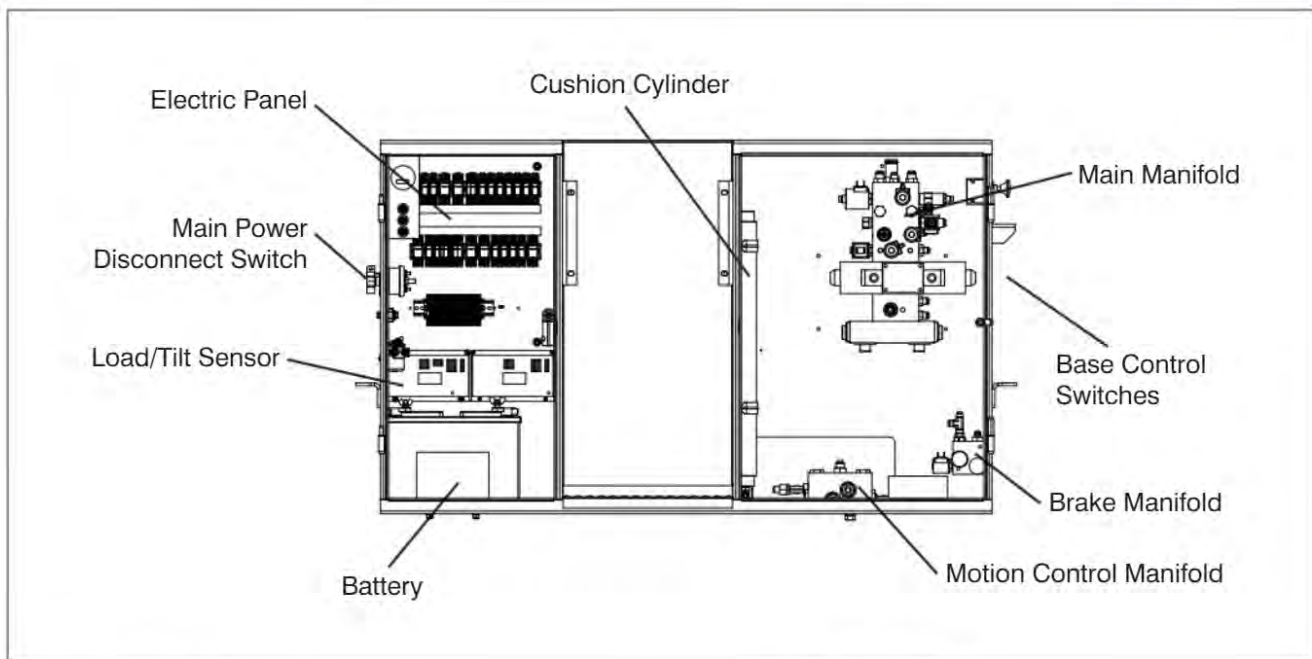

- **Manifolds**
 - Ensure all fittings and hoses are properly tightened and there is no evidence of hydraulic leakage.
 - Ensure there are no loose wires or missing fasteners.
- **Electrical Panel**
 - Ensure panel is properly secured and there is no visible damage.
 - Ensure there are no loose wires or missing fasteners.
- **Load/Tilt Sensor**
 - Ensure load/tilt sensor is properly secured and there is no visible damage.
- **Hydraulic Tank (Model 92xx)**
 - Ensure hydraulic filler cap is secure.
 - Ensure tank shows no visible damage and no evidence of hydraulic leakage.
- **Hydraulic Oil**
 - Ensure platform is fully lowered, and outriggers retracted, and then visually inspect the sight gauge located on the side of the hydraulic oil tank. Check oil level against label that indicates minimum and maximum oil levels (Model 92xx).
 - The hydraulic oil level should be at or slightly above the top mark of the sight glass (Models 88xx).

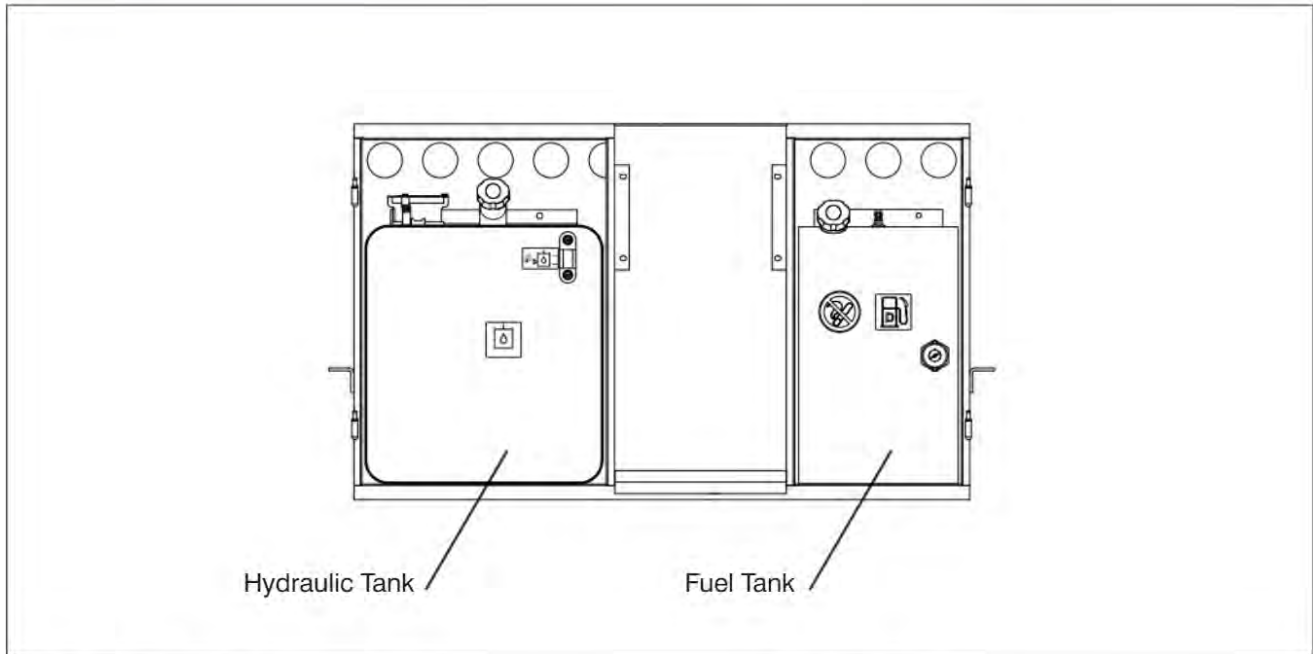

2.3-7 Hydraulic/Fuel Compartment

- Ensure all compartment latches are secure and in proper working order.
- **Hydraulic Tank (Models 88xx)**
 - Ensure hydraulic filler cap is secure.
 - Ensure tank shows no visible damage and no evidence of hydraulic leakage.
- **Hydraulic Oil (Models 88xx)**
 - Ensure platform is fully lowered, and then visually inspect the sight gauge located on the side of the hydraulic oil tank.
 - The hydraulic oil level should be at or slightly above the top mark of the sight glass.
- **Fuel Tank**

IMPORTANT

Before using your aerial platform ensure there is enough fuel for expected use.

- Ensure fuel filler cap is secure.
- Ensure tank shows no visible damage and no evidence of fuel leakage.

- **Fuel Leaks**

- Ensure that there no fuel leaks.



DANGER

Engine fuels are combustible. Inspect the aerial platform in an open, well-ventilated area away from heaters, sparks and flames. Always have an approved fire extinguisher within easy reach.

- Ensure fuel tank, hoses and fittings show no visible damage and no evidence of fuel leakage.

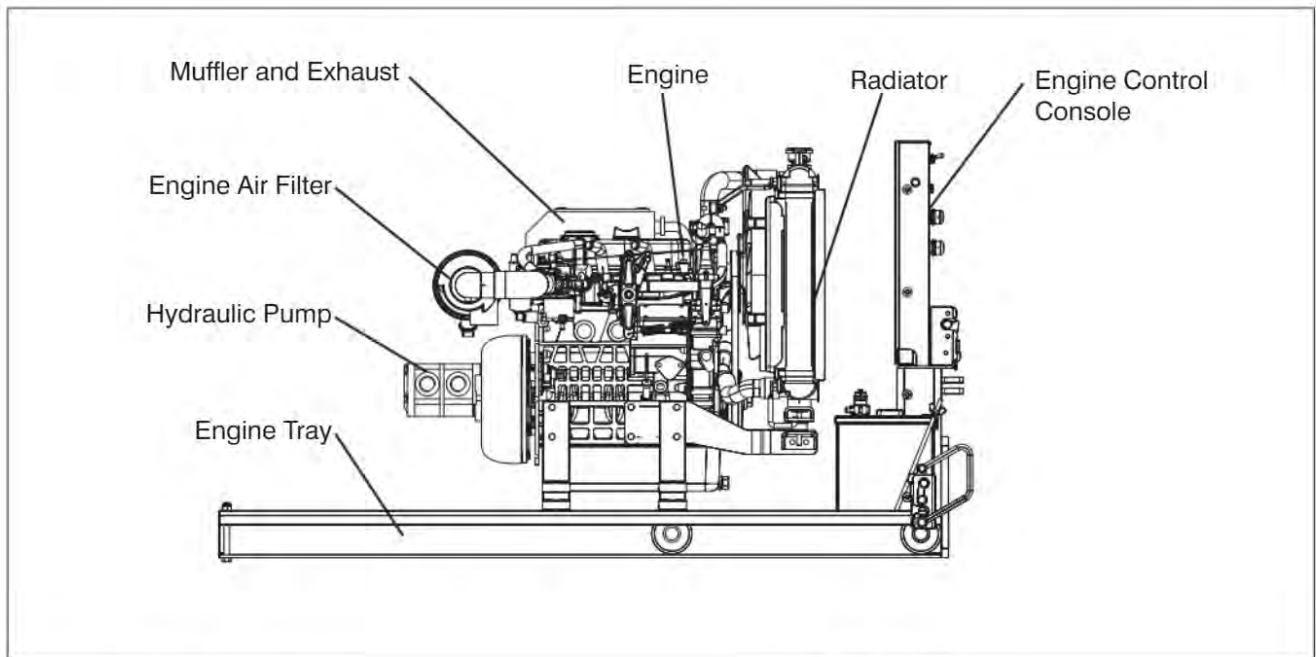

2.3-8 Engine Compartment



WARNING

Beware of hot engine components.

1. Pull on the two latches to pull out engine compartment.

- **Engine Control Console**
 - Ensure muffler and exhaust system are properly secured, with no evidence of damage.
- **Radiator**
 - Ensure radiator is secure.
 - Ensure there are no loose or missing parts and there is no visible damage.
 - Check coolant level and add as needed.
- **Muffler and Exhaust**
 - Ensure muffler and exhaust system are properly secured, with no evidence of damage.
- **Engine Tray**
 - Ensure there are no loose or missing parts and no visible damage to the engine tray. Ensure that both tray-securing bolts are in place.

- **Hydraulic Pump**
 - Ensure there are no loose or missing parts and there is no visible damage.
 - Ensure all bolts are properly tightened.
 - Ensure all fittings and hoses are properly tightened and there is no evidence of hydraulic leakage.
- **Engine Oil Level**
 - Maintaining the engine components is essential to good performance and service life of the aerial platform.

Check oil level on dipstick

 - Oil level should be between the “L” and “H” marks. Add oil as needed.
- **Engine Air Filter**
 - Ensure there are no loose or missing parts and there is no visible damage.

FAMILIARIZATION



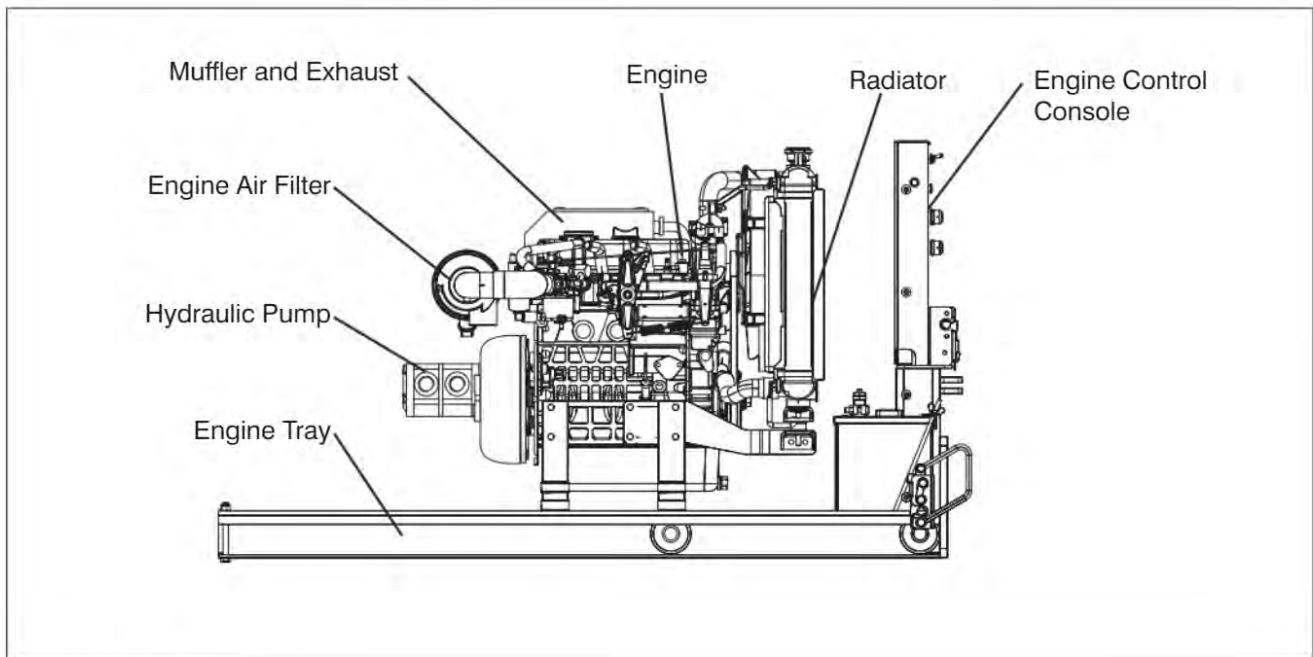

- **Fuel Leaks**
 - Ensure there are no fuel leaks.



DANGER

Engine fuels are combustible. Inspect the aerial platform in an open, well-ventilated area away from heaters, sparks and flames. Always have an approved fire extinguisher within easy reach.

- Ensure fuel pump, fuel filter, hoses and fittings show no visible damage and no evidence of fuel leakage.
2. Push in engine compartment until the two latches lock to base.

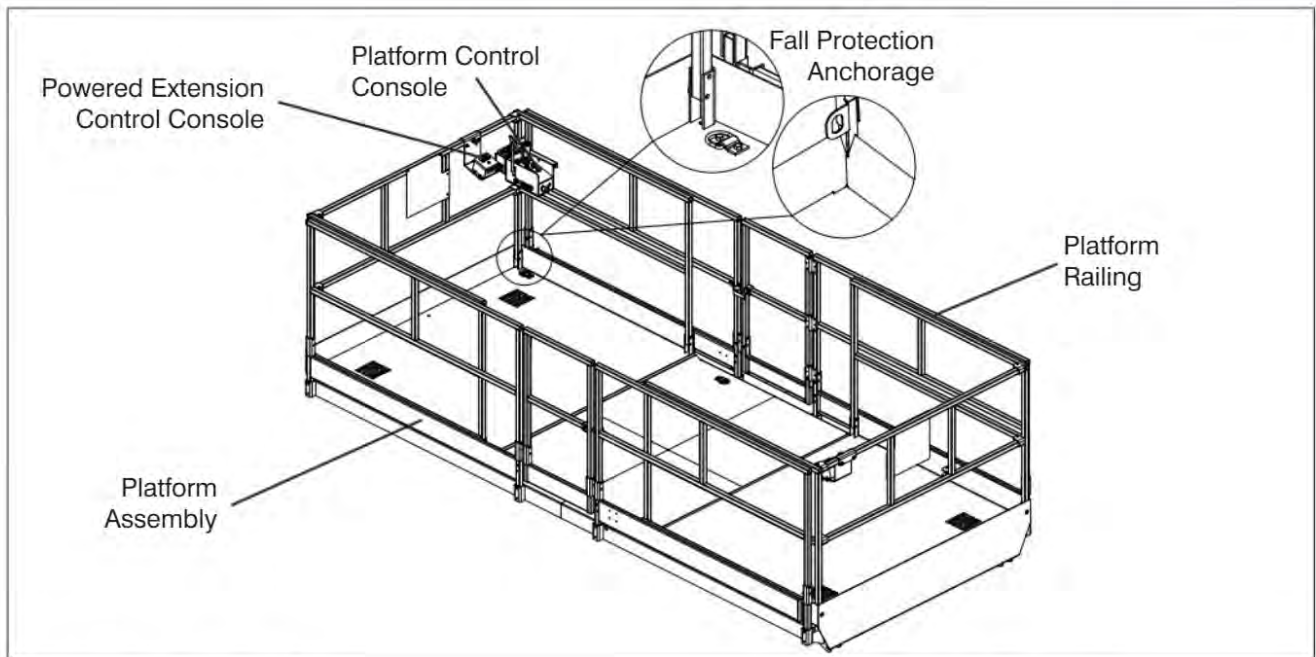

2.3-9 Platform Assembly



WARNING

Ensure that you maintain three points of contact to mount/dismount platform.

1. Use the ladder of aerial platform to access platform.
2. Close the gate.
 - Ensure there are no loose or missing parts and there is no visible damage.
 - Ensure all fasteners are securely in place.
 - Ensure all railings are properly positioned and secured.
 - Ensure gate is in good working order.
- **Fall Protection Anchorage(s)**
 - Ensure anchorage(s) are secure and there is no visible damage.
- **AC Outlet on Platform**
 - Ensure outlet has no visible damage and free from dirt or obstructions.

- **Platform Control Console**
 - Ensure all switches and controller are returned to neutral and are properly secured.
 - Ensure there are no loose or missing parts and there is no visible damage.
- **Powered Extension Control Console**
 - Ensure all switches are returned to neutral and are properly secured.
 - Ensure there are no loose or missing parts and there is no visible damage.



WARNING

Ensure that you maintain three points of contact to mount/dismount platform.

3. Use the ladder to dismount from platform.

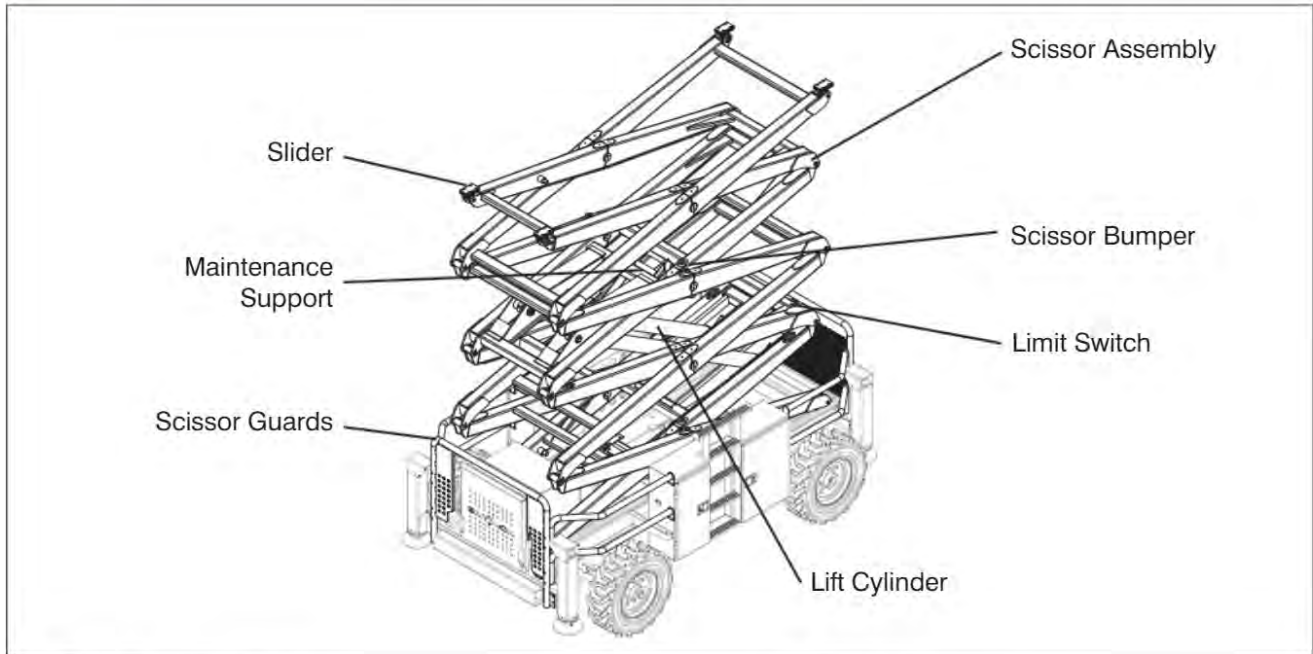

2.3-10 Lifting Mechanism

- **Scissor Guards**
 - Ensure there are no loose or missing parts and there is no visible damage.
- **Sliders**
 - Ensure sliders are secure and there is no visible damage.
 - Ensure sliders' path of travel are free from dirt and obstructions.
- 1. Raise the platform (refer to [Section 3.8-2](#)) until there is adequate clearance to swing down the maintenance support (refer to [Section 3.12](#)).
- **Maintenance Support**
 - Ensure maintenance support is properly secured and shows no visible damage.
- **Scissor Assembly**
 - Ensure scissor assembly shows no visible damage and no signs of deformation in weldments.
 - Ensure all pins are properly secured.
 - Ensure cables and wires are properly routed and shows no signs of wear and/or physical damage.
- **Scissor Bumpers**
 - Ensure bumpers are secure and shows no sign of visible damage.
- **Lift Cylinder(s)**
 - Ensure each lift cylinder is properly secured, there are no loose or missing parts and there is no evidence of damage.
 - Ensure all fittings and hoses are properly tightened and there is no evidence of hydraulic leakage.
- 2. Raise the platform until there is adequate clearance to swing up the maintenance support into storage bracket. Refer to [Section 3.12](#).
- 3. Fully lower the platform.

Typical Model 92xx shown - Bottom View

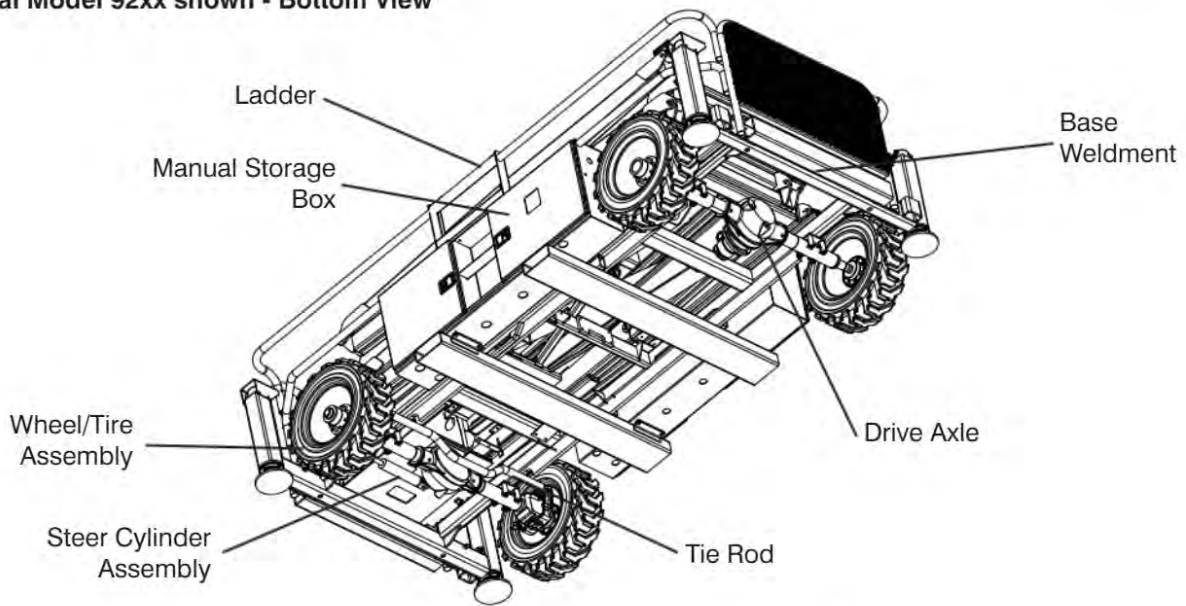

2.3-11 Base

- **Base Weldment**
 - Ensure there are no visible cracks in welds or structure and there are no signs of deformation.
- **Wheel/Tire Assembly**

The aerial platform is equipped with foam-filled tires. Tire and/or wheel failure could result in an aerial platform tipover. Component damage may also result if problems are not discovered and repaired in a timely fashion.

 - Check all tire treads and sidewalls for cuts, cracks, punctures and unusual wear.
 - Check each wheel for damage and cracked welds.
 - Check each lug nut for proper torque to ensure none are loose.

Refer to [Table 4.6](#) for wheel/tire specifications.

**WARNING**

Intermixing tires of different types or using tires of types other than those originally supplied with this equipment can adversely affect stability. Therefore, replace tires only with the exact Skyjack-approved type. Failure to operate with matched approved tires in good condition may result in death or serious injury.

- **Drive Axle**
 - Ensure drive axle is properly secured, there are no loose or missing parts, all fittings and hoses are properly tightened and there is no evidence of hydraulic leakage.
- **Steer Cylinder Assembly**
 - Ensure steer cylinder assembly is properly secured, there are no loose or missing parts, all fittings and hoses are properly tightened and there is no evidence of hydraulic leakage.
- **Tie Rod**
 - Ensure there are no loose or missing parts, tie rod end studs are locked and there is no visible damage.

Typical Model 92xx shown - Bottom View

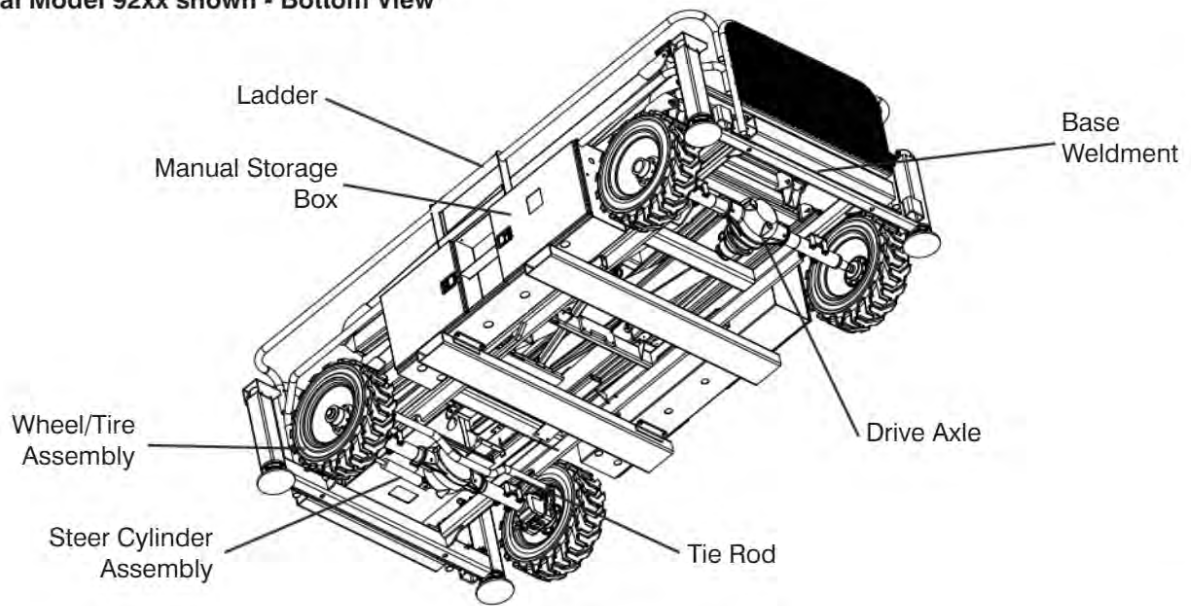

- **Ladder**
 - Ensure there are no loose or missing parts and there is no visible damage.
- **Outriggers (If Equipped)**
 - Ensure there are no loose or missing parts and there is no visible damage.

2.3-12 Manuals

Ensure a copy of operating manual is enclosed in manual storage box.

- Check to be sure manual storage box is present and in good condition.
- Ensure manuals are legible and in good condition.
- Always return manuals to the manual storage box after use.

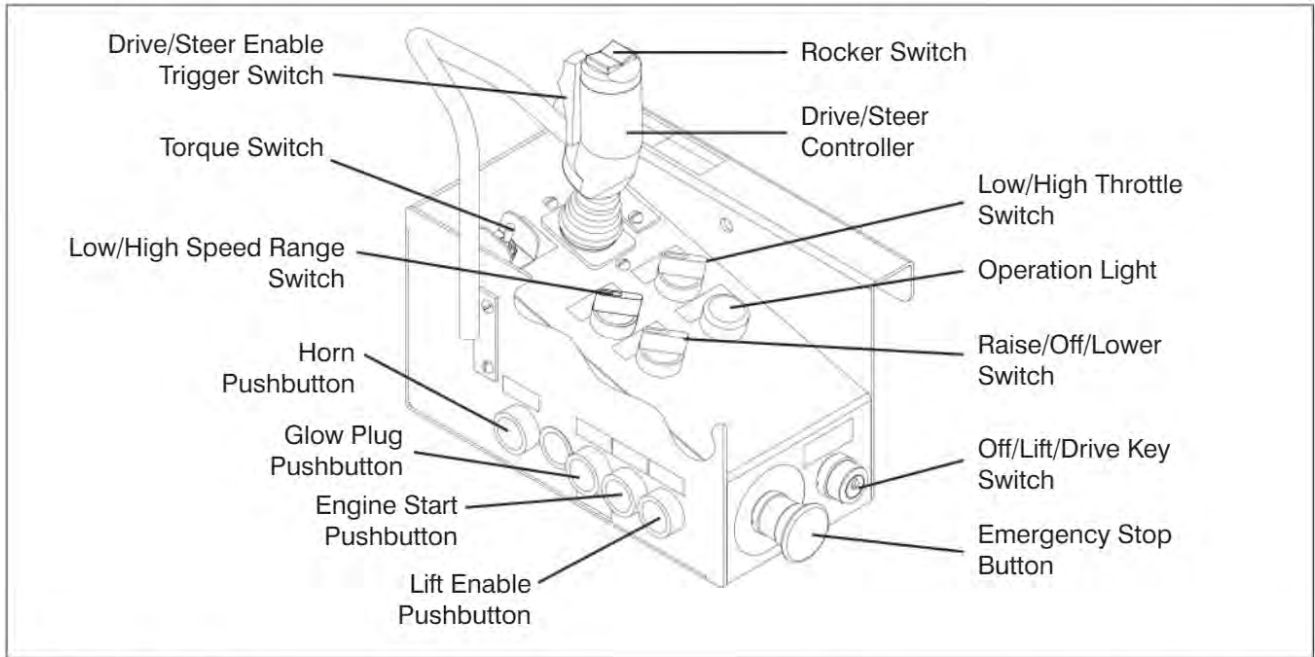

2.4 Function Tests

Function tests are designed to discover any malfunctions before aerial platform is put into service. The operator must understand and follow step-by-step instructions to test all aerial platform functions.





WARNING
Never use a malfunctioning aerial platform. If malfunctions are discovered, aerial platform must be tagged and placed out of service. Repairs to aerial platform may only be made by a qualified service technician.

After repairs are completed, operator must perform a pre-operation inspection and a series of function tests again before putting aerial platform into service.

Prior to performing function tests, be sure to read and understand [Section 3.8 - Start Operation](#).



2.4-1 Platform Control Console

1. Turn main power disconnect switch to “|” on position.
2. On engine control console, select off/on/start switch to “|” on position.
3. On base control console, pull out “” emergency stop button.

4. Select off/platform/base key switch to “” platform position.





WARNING
Ensure that you maintain three points of contact when using the ladder to mount/dismount platform.

5. Use the ladder of aerial platform to access platform.
6. Close the gate.
7. On platform control console, insert key into off/lift/drive key switch and select “” lift position.
8. Pull out “” emergency stop button. A beeping sound should be audible and light should come on.



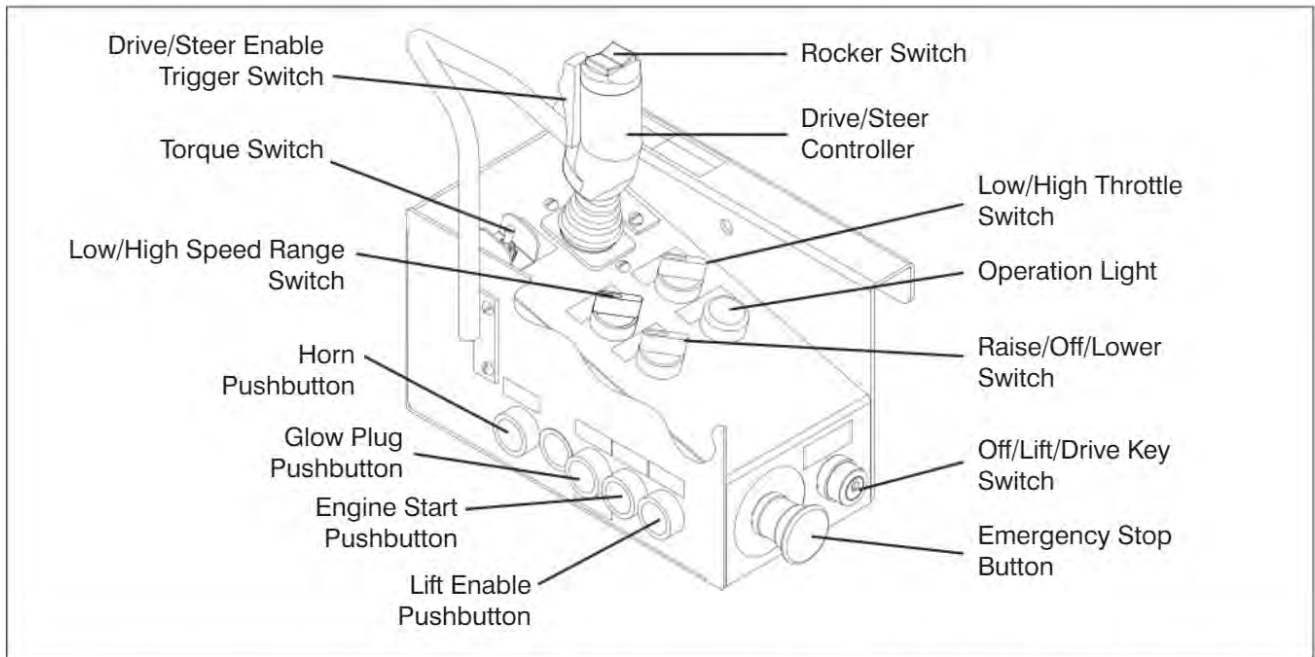

WARNING
If beeping sound is not audible and light does not come on, aerial platform must be tagged and placed out of service.



9. Select low/high throttle switch to “” low throttle position.

CAUTION

Do not start the engine in the high throttle position.



10. If diesel engine is cold, depress and hold “” glow plug pushbutton for 15 to 20 seconds.
11. Depress and hold “” engine start pushbutton to start the engine.

• **Test Emergency Stop**

1. Push in “” emergency stop button.
Result: Engine should shut down and aerial platform functions should not operate.

• **Test Lift Enable**





1. Pull out “” emergency stop button.
2. Restart the engine.

3. Select and hold raise/off/lower switch to “” raise position without pressing lift “” enable pushbutton.
Result: Platform should not rise.

• **Test Platform Raising/Lowering**



WARNING

Be aware of overhead obstructions or other possible hazards around the aerial platform when lifting.

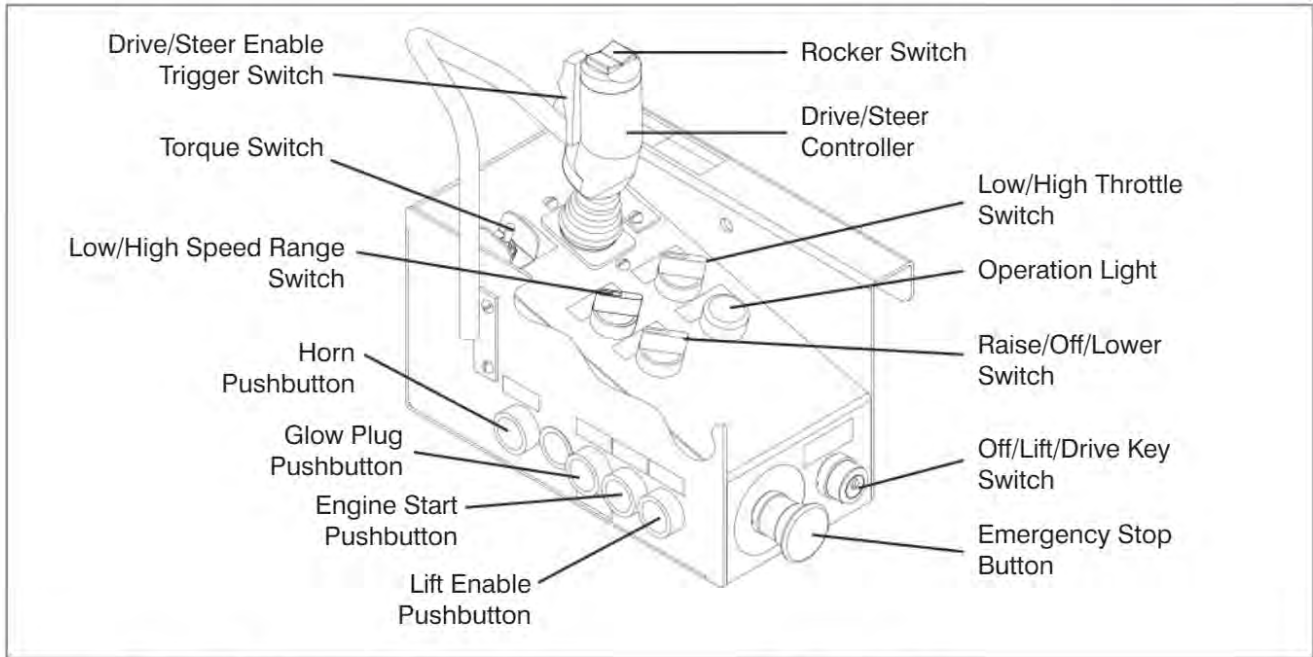

1. Press and hold lift “” enable pushbutton, then select and hold raise/off/lower switch to “” raise position and raise the platform to an approximate height of 0.5 meter. Release switch to stop.
Result: Platform should rise.
2. Press and hold lift “” enable pushbutton, then select and hold raise/off/lower switch to “” lower position and lower the platform fully. Release switch to stop.
Result: Platform should lower.



• **Test Enable Trigger Switch**

1. Ensure outriggers are fully retracted. Refer to [Section 3.8-10](#) for hydraulic outriggers operation.
2. Ensure path of intended motion is clear.
3. Select off/lift/drive key switch to “” drive position.
4. Without activating “” enable trigger switch, attempt to drive and steer the aerial platform.
Result: Drive and steer functions should not operate.



• **Test Steering**

1. Activate and hold enable trigger switch, and then press rocker switch on top of controller to “” left and “” right.
Result: Steer wheels should turn left and right.

• **Test Horn**

1. Push “” horn pushbutton.
Result: Horn should sound.

• **Test Driving**



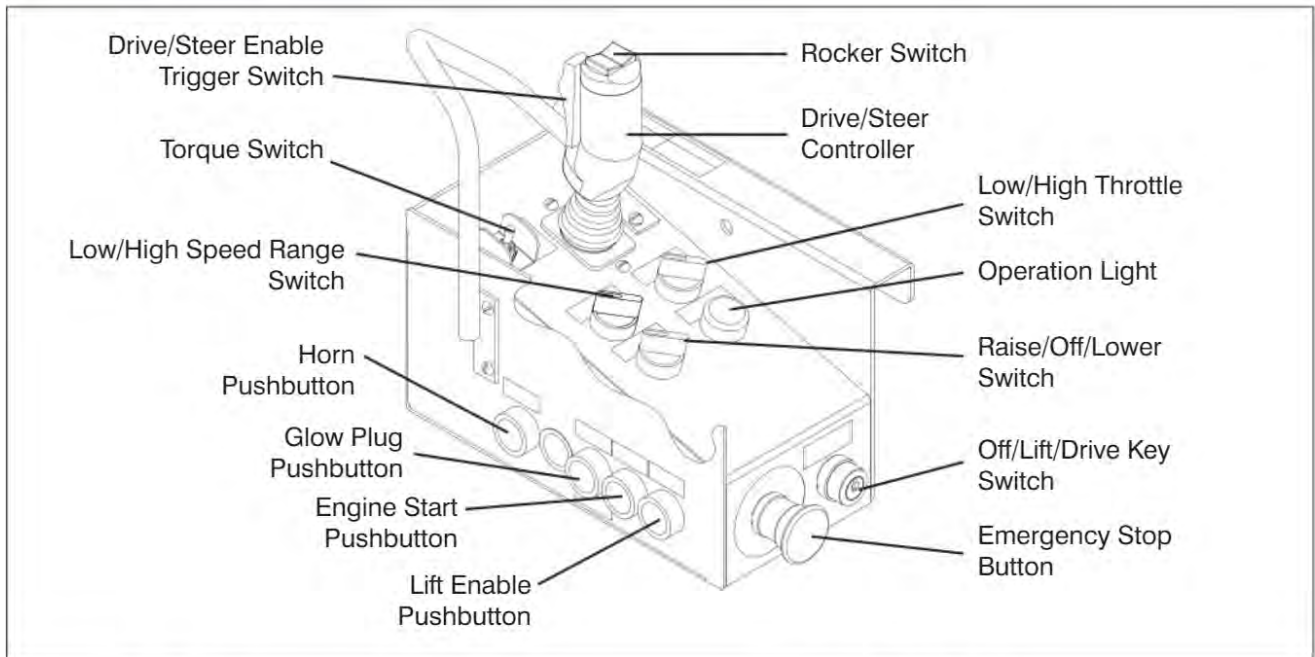

1. Ensure path of intended motion is clear.
2. Activate and hold “” enable trigger switch.
3. Slowly move controller fully “” forward, and then return handle to center position.
Result: Aerial platform should move in forward direction, and then come to a stop.
4. Slowly move controller fully “” backward, and then return handle to center position.
Result: Aerial platform should move in reverse direction, and then come to a stop.



• Test Brake





WARNING
 Brake will engage instantly when controller handle is released, causing aerial platform to stop immediately.

1. Ensure path of intended motion is clear.
2. Activate and hold “” enable trigger switch.
3. Drive aerial platform “” forward. Test brake by releasing controller handle.
Result: Aerial platform should come to a stop.
4. Drive aerial platform “” forward. Test brake again by releasing “” enable trigger switch only.
Result: Aerial platform should come to an instant and abrupt stop.

• Test Speed Limit



WARNING
 Be aware of overhead obstructions or other possible hazards around the aerial platform when lifting.

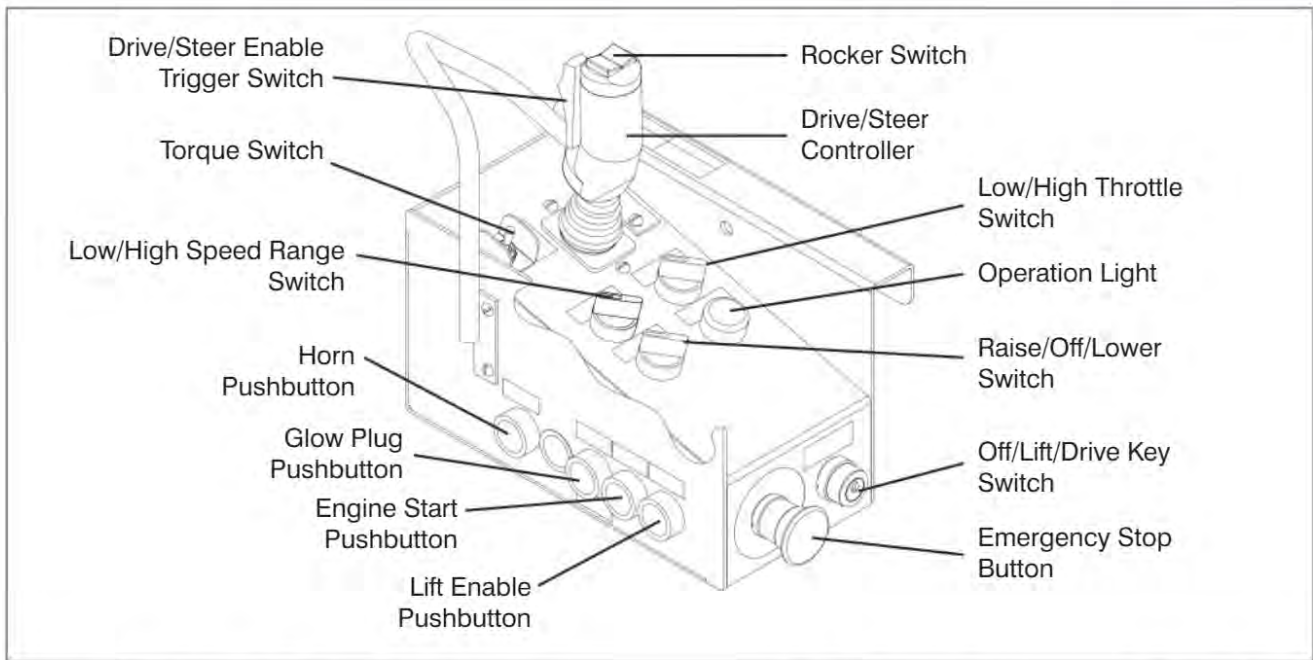

1. Ensure path of intended motion is clear.
2. Select off/lift/drive key switch to “” lift position.
3. Raise the platform to an approximate height of 4 meters.
4. Select off/lift/drive key switch to “” drive position and attempt to drive forward or reverse.
Result: Aerial platform should move slower than when it was in stowed position.



• **Test Lowering Warning**

1. Select off/lift/drive key switch to “ lift position.
2. Fully lower the platform.
Result: Platform should stop lowering at an approximate height of 2.5 meters and an alarm should sound.
3. Release platform raise/off/lower switch, ensure area around scissor is clear, then continue lowering the platform.
4. Lower the platform fully.

• **Test Powerdeck Enable (If Equipped)**



1. Select and hold extend/retract switch to the “ extend position without selecting “ enable switch.
Result: Platform should not extend.

• **Test Extension Platform(s) (If Equipped)**

1. Extend each extension platform to about .5 meter (refer to [Section 3.8-8](#) or [Section 3.8-9](#)).
Result: Each extension platform should extend.

2. Retract each extension platform fully.
Result: Each extension platform should fully retract.

• **Test Emergency Powered Extension Platform Retraction Switch (Model 9250)**

1. Extend both powered extension platforms to about .5 meter.
2. Push in “ emergency stop button to shut down the engine.
3. Pull out “ emergency stop button.



Ensure that you maintain three points of contact when using the ladder to mount/dismount platform.

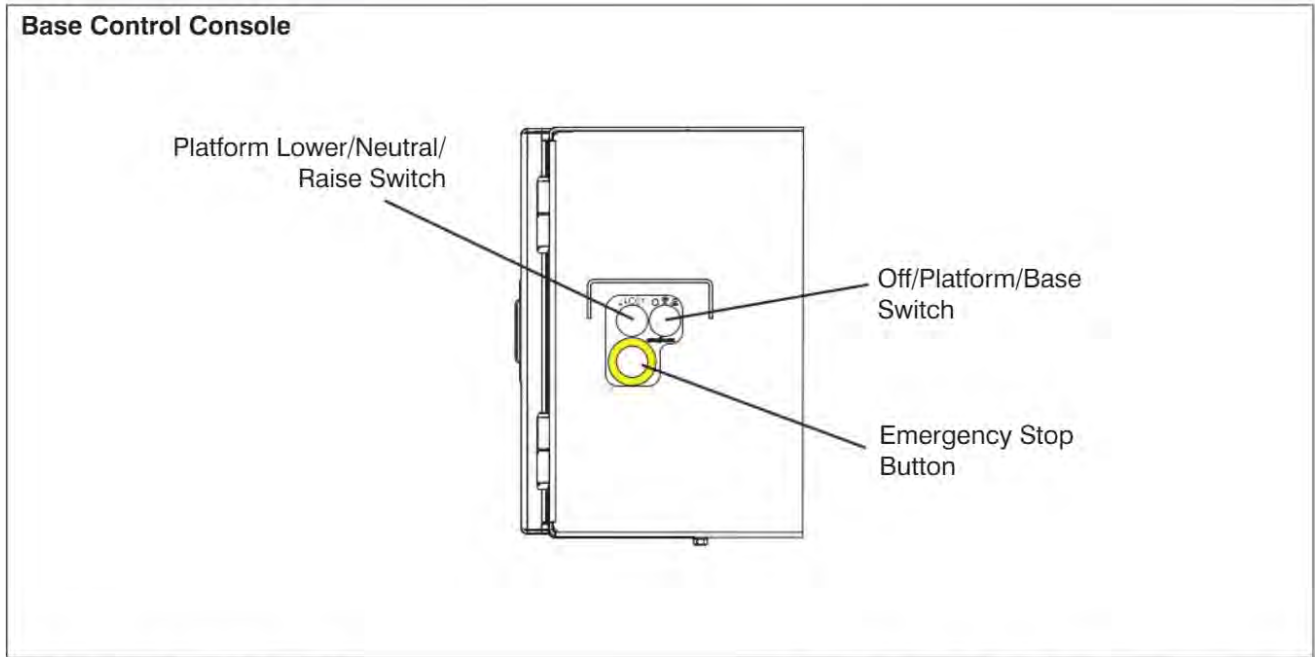

4. Use the ladder to dismount from platform.
5. On hydraulic/electric tray, push the emergency powered extension platform retraction switch.
Result: Extension platforms should retract.



2.4-2 Base Control Console

- 1. On engine control console, select “” start position to start the engine.

- **Test Emergency Stop**

- 1. Push in “” emergency stop button.
Result: Engine should shut down and aerial platform functions should not operate.
- 2. Pull out “” emergency stop button and restart engine.

- **Test Off/Platform/Base Switch**







WARNING
Be aware of overhead obstructions or other possible hazards around the aerial platform when lifting.

- 1. Select off/platform/base key switch “” off position. Attempt to raise or lower the platform.
Result: Platform raising and lowering functions should not operate.

- 2. Select off/platform/base key switch to “” platform position. Attempt to raise or lower the platform.
Result: Platform raising and lowering functions should not operate.

- 3. Select and hold off/platform/base key switch to “” base position. Attempt to raise or lower the platform.
Result: Platform raising and lowering functions should operate.

- **Test Lower/Neutral/Raise Switch**

- 1. Select and hold off/platform/base key switch to “” base position and “” raise the platform with lower/neutral/raise switch.
Result: Platform should rise.
- 2. Select and hold off/platform/base key switch to “” base position and “” lower the platform with lower/neutral/raise switch.
Result: Platform should lower.

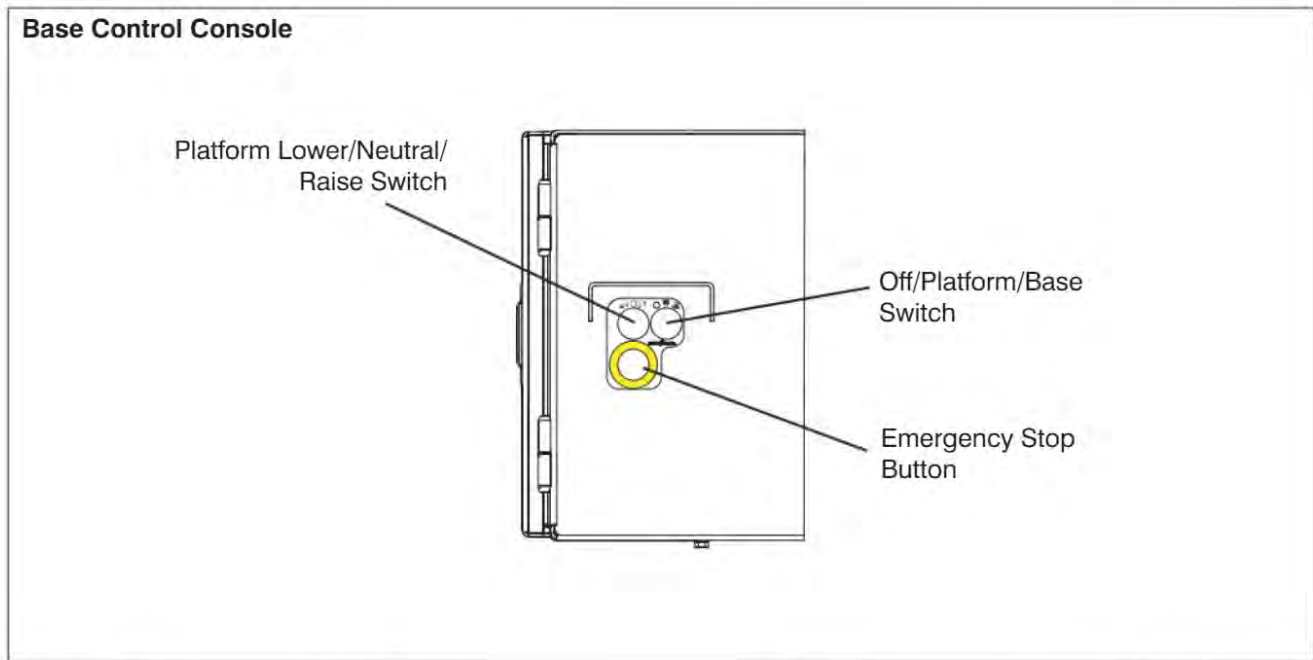

- Test Emergency Lowering (Models 88xx & 9241)



WARNING
Be aware of overhead obstructions or other possible hazards around the aerial platform when lifting.

1. Raise the platform to an approximate height of 4 meters.
2. Turn main power disconnect switch to “○” off position.
3. Locate holding valve manual override knob at the base of each lift cylinder. Depress and turn counterclockwise. If necessary, use emergency lowering access rod that is located either at the base, on top of scissor guards, or on top of fuel cabinet.
4. On hydraulic/electrical compartment, pull out and hold emergency lowering valve to fully lower the platform.
Result: Platform should fully lower.
5. To restore normal operation, depress and turn holding valve manual override knobs clockwise.

- Test Emergency Lowering (Model 9250)



WARNING
Be aware of overhead obstructions or other possible hazards around the aerial platform when lifting.

1. Raise the platform to an approximate height of 4 meters.
 2. Turn main power disconnect switch to “○” off position.
 3. In hydraulic/electrical compartment, depress and hold emergency lowering pushbutton to activate the auxiliary lowering valves. Pull out and hold the emergency lowering valve to fully lower platform.
Result: Platform should fully lower.
- Test Main Power Disconnect Switch
1. On hydraulic/electrical compartment, turn main power disconnect switch to “○” off position.
Result: Engine should shut down and aerial platform functions should not operate.

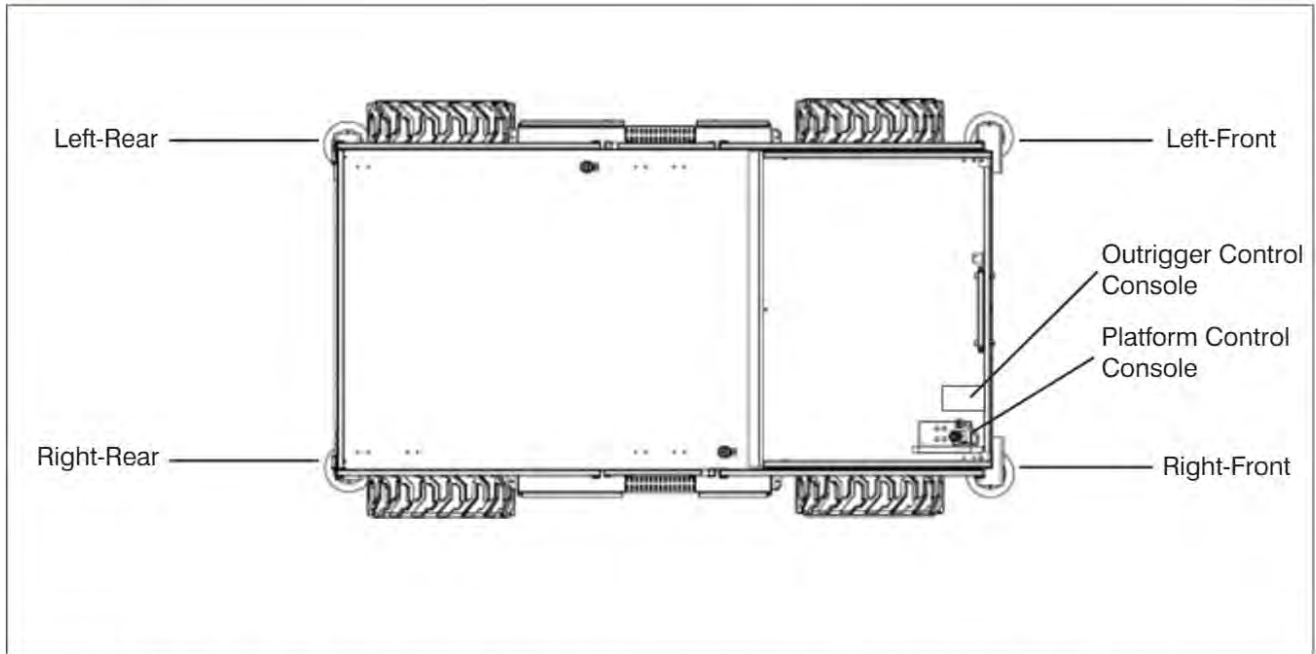

- **Test Hydraulic Outriggers** (For Hydraulic Outrigger Operation, refer to [Section 3.8-10](#))

1. Ensure aerial platform is parked on a firm level surface and free from obstructions.
2. Ensure platform is fully lowered.
3. Ensure outriggers are fully retracted.
4. Auto-level (If equipped):
Use auto-level to extend outriggers.
Result: All four outriggers will extend until they are supporting weight and bring machine to within level.
5. Once auto-level is complete, attempt to lift platform 1 foot and then lower the platform to stowed position.
Result: Platform will lift and lower.
6. With platform at stowed position, fully retract all outriggers using auto-level.
Result: All four outriggers will retract until they are in the stowed (up) position.

**WARNING**

Ensure that there are no personnel or obstructions in the path of travel, including blind spots.

7. Drive the aerial platform to maximum speed.
Result: Aerial platform drives at high speed.

**WARNING**

Be aware of overhead obstructions or other possible hazards around the aerial platform when lifting or driving.

8. Lift platform to 12 feet (measured from the bottom of the tires to the platform surface) from stowed position.
Result: Lift function will operate.
9. Drive aerial platform at raised height (12 feet).
Result: Aerial platform drives at slow speed.
10. Attempt to operate outriggers at raised height (12 feet).
 - Attempt to partially extend Left-Front Outrigger (approximately 4").
Result: Outrigger will not extend.
 - Attempt to partially extend Right-Front Outrigger (approximately 4").
Result: Outrigger will not extend.

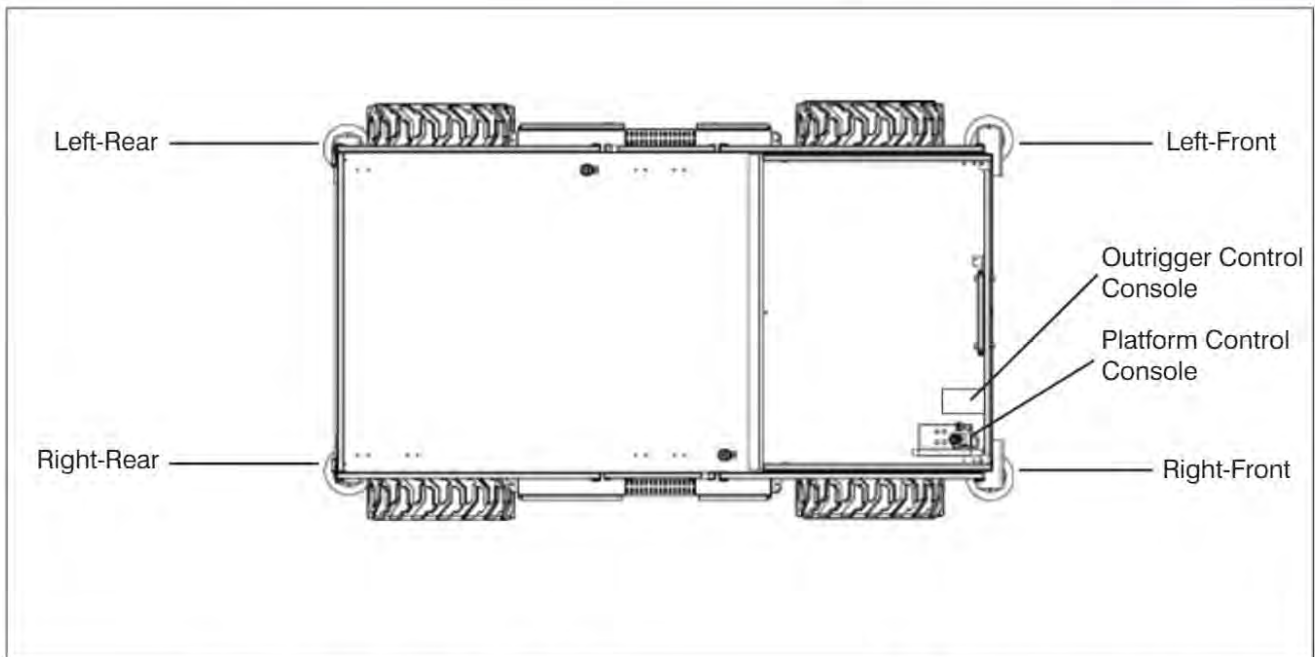

- Attempt to partially extend Right-Rear Outrigger (approximately 4").
Result: Outrigger will not extend.

- Attempt to partially extend Left-Rear Outrigger (approximately 4").
Result: Outrigger will not extend.

11. Lower the platform to stowed position.
Result: Lower function will operate.

12. Raise the platform 1 foot from stowed position and partially extend Left-Front Outrigger (approximately 4").

- Attempt to lift the platform.
Result: Lift function will not operate.

- Attempt to drive the aerial platform.
Result: Drive function will not operate.

- Attempt to lower the platform.
Result: Lower function will operate.

13. Platform at stowed position.

- With Left-Front Outrigger partially extended, attempt to lift the platform.
Result: Lift function will not operate.

- With Right-Front Outrigger partially extended, attempt to lift the platform.
Result: Lift function will not operate.
- With Right-Rear Outrigger partially extended, attempt to lift the platform.

Result: Lift function will not operate.

- With Left-Rear Outrigger partially extended, attempt to lift the platform.
Result: Lift function will not operate.

14. Platform at stowed position.

- Extend each outrigger until it raises the tires up approximately 2".

- Retract the Left-Front Outrigger until the weight is resting on the corresponding tire.

- Extend the Right-Rear Outrigger until it makes contact with ground.

- Attempt to lift the platform 1 foot.
Result: Lift function will not operate.

15. Platform at stowed position.

- Extend each outrigger until it raises the tires up approximately 2".

- Retract the Right-Front Outrigger until the weight is resting on the corresponding tire.

- Extend the Left-Rear Outrigger until it makes contact with ground.

- Attempt to lift the platform 1 foot.
Result: Lift function will not operate.

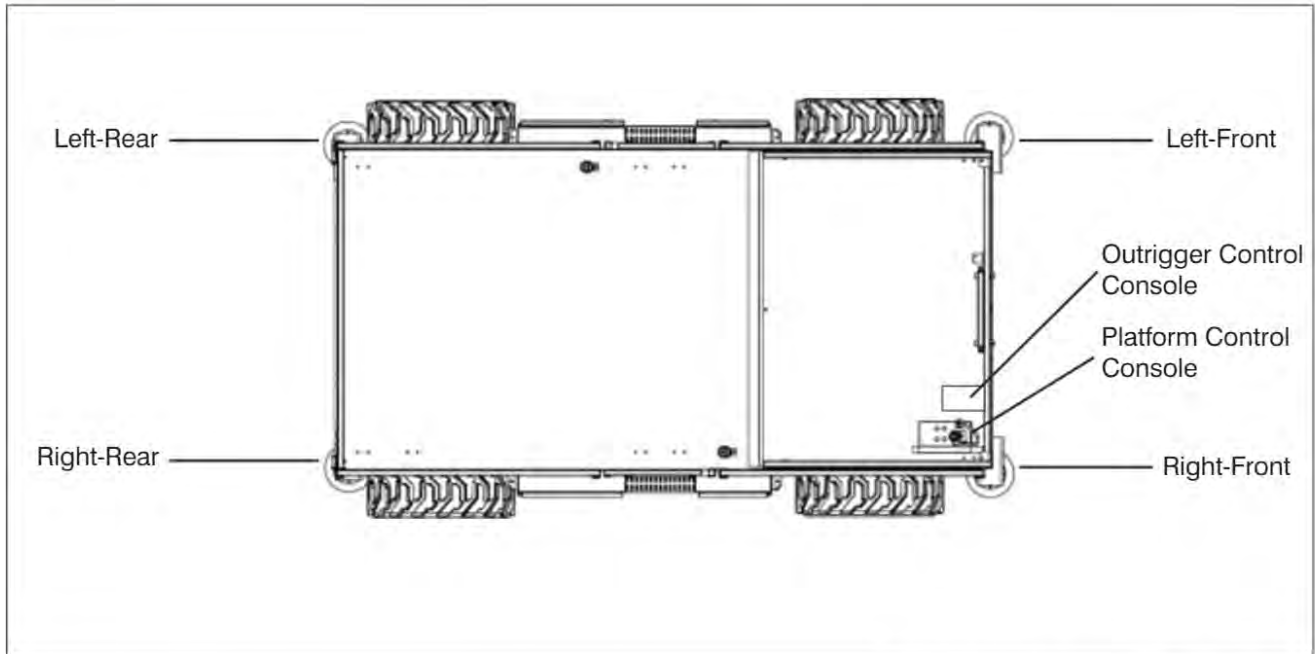

16. Platform at stowed position.
- Extend each outrigger until it raises the tires up approximately 2".
 - Retract the Right-Rear Outrigger until the weight is resting on the corresponding tire.
 - Extend the Left-Front Outrigger until it makes contact with ground.
 - Attempt to lift the platform 1 foot.
Result: Lift function will not operate.

17. Platform at stowed position.
- Extend each outrigger until it raises the tires up approximately 2".
 - Retract the Left-Rear Outrigger until the weight is resting on the corresponding tire.
 - Extend the Right-Front Outrigger until it makes contact with ground.
 - Attempt to lift the platform 1 foot.
Result: Lift function will not operate.

18. Extend all four outriggers until all tires are off the ground and the aerial platform is levelled.
- Lift the platform to 12 feet.

Result: Lift function will operate.

- Lower the platform from raised height (12 feet).

Result: Lower function will operate.



WARNING

If any outrigger interlocks fail to operate in the expected manner, the aerial platform should be tagged and removed from operation immediately.



WARNING

Repairs to the aerial platform may only be made by a qualified service technician.

2.5 Winching and Towing Procedure

This section provides the operator with procedures regarding winching, towing and manual brake release.

WARNING

Ensure platform is fully lowered before winching or towing. Sudden motion could cause aerial platform to become unstable. Death or serious injury could result.

WARNING

In emergency situations where aerial platform functions are not available and lowering is impeded by an obstacle, utmost care must be taken to move aerial platform far enough to clear obstacle. In such cases, operation must be extremely smooth with no sudden movements and must not exceed a speed of 50 mm/sec.

WARNING

When pushing, winching or towing, do not exceed 3.2 km/h.

WARNING

Do not push, winch or tow aerial platform onto a slope. Do not stop the towing vehicle rapidly. Do not pull aerial platform down an incline.

2.5-1 To Release the Brake Manually

WARNING

Do not manually disengage brake if the aerial platform is on an incline.

WARNING

Brake must be manually disengaged before pushing, winching or towing.

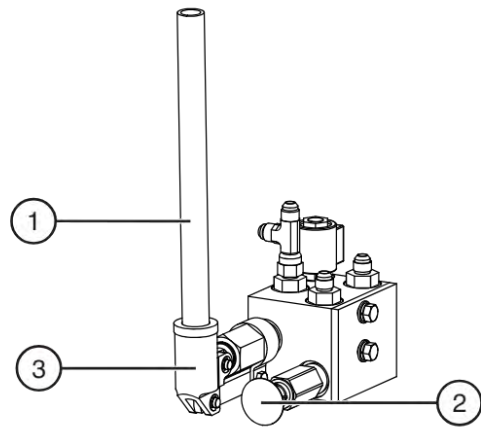

Figure 2-9. Brake System

- 1. Brake Lever
- 2. Brake Auto Reset Valve Plunger
- 3. Brake Pump

1. Ensure aerial platform is on level ground. Chock or block wheels to prevent aerial platform from rolling.
2. Turn main power disconnect switch to “O” off position.
3. Locate the manifold and lever in hydraulic/ electrical compartment. Insert brake lever (item 1) into brake release pump (item 3).
4. Push in brake auto reset valve plunger (item 2).
5. Pump brake lever (item 1) 1-3 times until firm resistance is felt. The brake is now released. Remove brake lever and secure in clips.
6. Remove wheel chocks or blocks then push, winch or tow aerial platform to desired location.

WARNING

Brake must be reengaged immediately after reaching desired location.

7. Position aerial platform on a firm and level surface.
8. Chock or block wheels to prevent aerial platform from rolling.
9. Reengage brake by pulling out brake valve plunger.

2.6 Emergency Lowering Procedures

This section guides the operator on how to use the emergency lowering system. This system allows platform lowering in the event of an emergency or malfunction.

Models 88xx & 9241



WARNING

Keep clear of scissors mechanism when using emergency lowering valve.

1. Remove any obstructions to a descending platform.
2. Extension platform(s) may need to be retracted or aerial platform may need to be moved to clear obstructions. Refer to [Section 2.5](#) for winching and towing procedures.

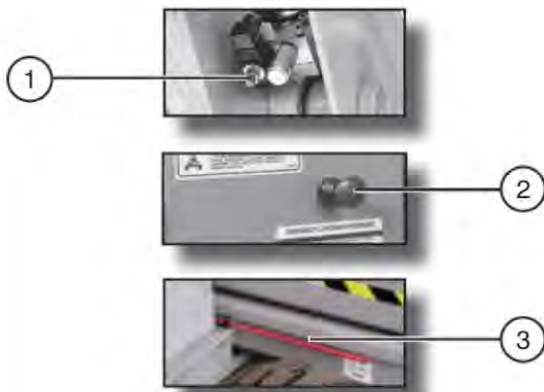

Figure 2-10. Emergency Lowering System

3. Turn main power disconnect switch to “○” off position.
4. Locate holding valve override knobs (item 1) at base of each lift cylinder. Depress and turn counterclockwise. If necessary, use emergency lowering access rod (item 3) that is located on aerial platform base or on top of fuel cabinet.
5. On the hydraulic compartment, pull out and hold emergency lowering valve (item 2) to lower platform.
6. To restore normal operation, depress and turn holding valve override knobs clockwise.

Model 9250



WARNING

Keep clear of scissors mechanism when using emergency lowering valve.

1. Remove any obstructions to a descending platform.



WARNING

Ensure platform and extensions including railing are clear of obstructions before operating emergency powered extension platform retraction switch.

2. Extension platform(s) may need to be retracted or aerial platform may need to be moved to clear the obstructions. Refer to [Section 2.5](#) winching and towing procedures. Model 9250 are equipped with emergency powered extension platform retraction switch (located in the hydraulic/electrical compartment) to retract the powered extension platform from the base (item 1).

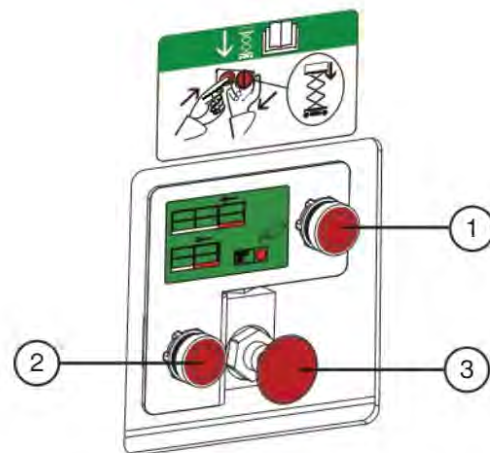

Figure 2-11. Emergency Lowering System

3. Turn main power disconnect switch to “○” off position.
4. In hydraulic compartment, depress and hold emergency lowering pushbutton (item 2) to activate the auxiliary lowering valves. Pull out and hold the emergency lowering valve (item 3) to lower platform. No further actions are required to restore normal operation.

3.0 Operation

This section provides the necessary information needed to operate the aerial platform. It is important that the user reads and understands this section before operating the aerial platform.

3.1 General

In order for this aerial platform to be in good working condition, it is important that the operator meets the necessary qualifications and follow the maintenance and inspection schedule referred to in this section.

3.1-1 Operator Qualifications

- Only trained and authorized personnel shall be permitted to operate an aerial platform.
- Safe use of this aerial platform requires the operator to understand the limitations and warnings, operating procedures and operator's responsibility for maintenance. Accordingly, the operator must understand and be familiar with this operating manual, its warnings and instructions, and all warnings and instructions on the aerial platform.
- The operator must be familiar with employer's work rules and related government regulations and be able to demonstrate the ability to understand and operate this make and model of aerial platform in the presence of a qualified person.

3.1-2 Operator's Responsibility for Maintenance



WARNING

Maintenance must be performed by trained and competent personnel who are familiar with mechanical procedures.

Death or serious injury could result from the use of an aerial platform that is not properly maintained or kept in good working condition.

- The operator must be sure that the aerial platform has been properly maintained and inspected before using it.
- The operator must perform all the daily inspections and function tests found in [Table 4.7](#), even if the operator is not directly responsible for the maintenance of this aerial platform.

3.1-3 Maintenance and Inspection Schedule

- The inspection points covered in [Table 4.7](#) indicate the areas of the aerial platform to be maintained or inspected and at what intervals the maintenance and inspections are to be performed.
- The actual operating environment of the aerial platform may affect the maintenance schedule.



WARNING

Use original or manufacturer-approved parts and components for the aerial platform.

3.1-4 Owner's Inspections

It is the responsibility of the owner to arrange daily, quarterly (or 150 hours) and annual inspections of the aerial platform. Refer to [Table 4.7](#) for recommended maintenance and inspection areas and intervals. A record of annual inspection is kept on a label located on the scissor assembly. Refer to [Table 4.2](#) in this manual.

3.2 Major Components

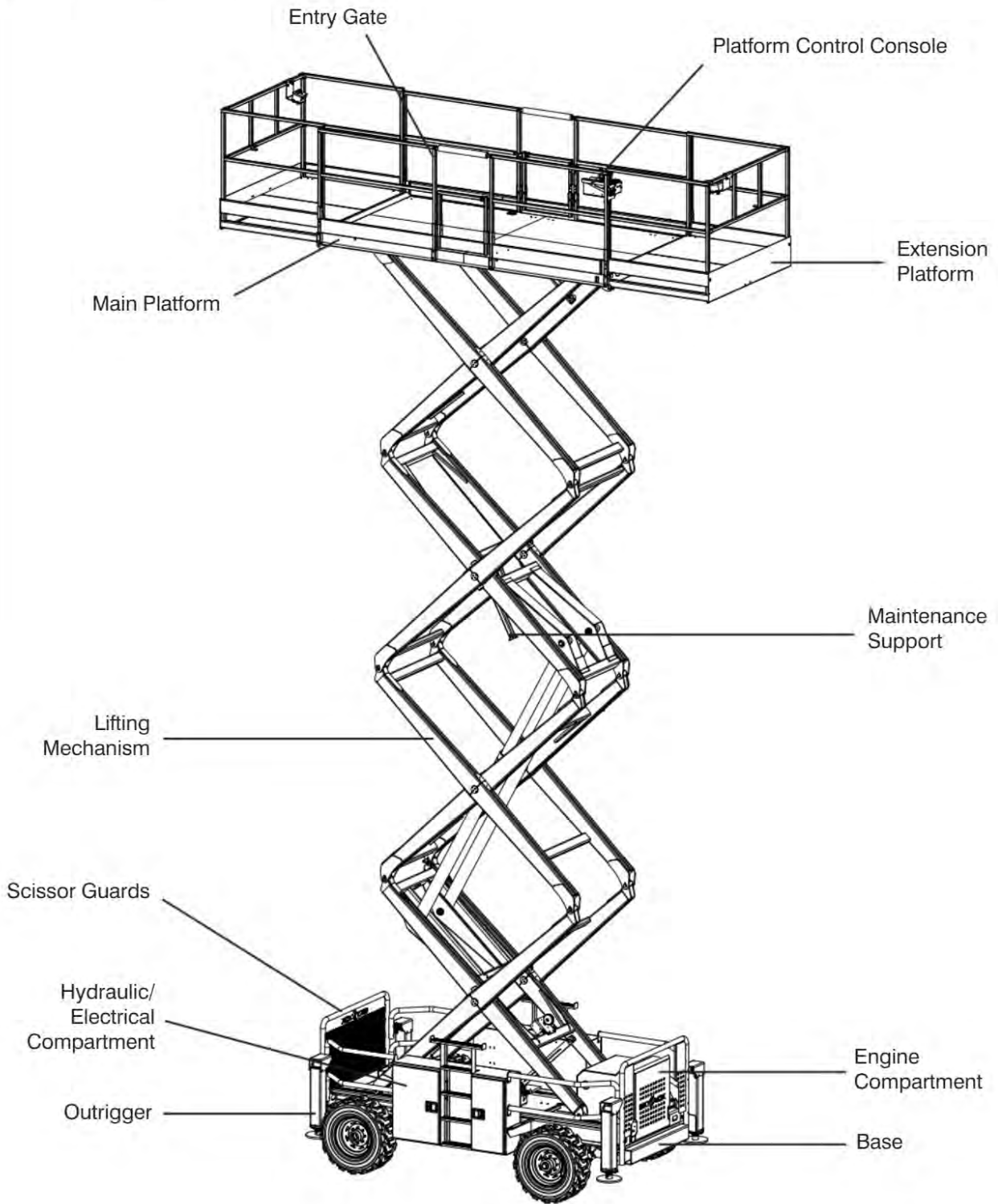

SKYJACK Model 8841 Aerial Platform

3.3 Major Assemblies

The aerial platform consists of three major assemblies: base, lifting mechanism and platform.

3.3-1 Base

The base is a rigid, one-piece weldment which supports two side compartments.

Models 88xx

- One compartment contains the hydraulic and electrical components, and base control console. The other compartment contains the fuel and hydraulic tanks.
- The front axle is steered by a hydraulic cylinder and is either non-driven (2WD) or drive shaft/gear box driven (4WD).
- The rear axle is drive shaft/gear box driven and has a spring-applied hydraulically released disc brake.
- A roll-out tray at the front of the base supports an engine coupled with a two-section hydraulic pump providing power to the hydraulic system.
- An engine control console is also located at the front of the base.
- The 12V starter battery is located in the hydraulic/electrical compartment or at the front of the engine roll-out tray.

Models 92xx

- One compartment contains the hydraulic tank, hydraulic and electrical components, base control console, emergency battery and starter battery.
- The other compartment contains the fuel tank.
- The front axle is steered by a hydraulic cylinder and is drive shaft/gear box driven (4WD).
- The rear axle is drive shaft/gear box driven and has a spring-applied hydraulically released disc brake.
- A roll-out tray at the front of the base supports an engine coupled with a two-section hydraulic pump providing power to the hydraulic system.
- An engine control console is also located at the front of the base.

3.3-2 Lifting Mechanism

The lifting mechanism is constructed of formed steel or tube sections making up a scissor-type assembly. The scissor assembly is raised and lowered by single-acting hydraulic lift cylinders with holding valves. A two-section pump, driven by an engine, provides hydraulic power to the lift cylinders.

3.3-3 Platform

The platform is constructed of a tubular support frame, a skid-resistant "diamond plate" platform surface and 1.1 m hinged guardrails with 0.15 m toe boards and mid-rails. The platform can be entered from either side through a spring-returned gate for full size RTs and from the rear through a spring-returned gate for mid size RTs. Some full size RTs can be equipped with a front or rear (or both) extension platform(s). The mid size RTs are equipped with a front extension platform. Models 92xx are equipped with two powered extension platforms. An AC outlet is also located on the platform.

3.4 Serial Number Nameplate

The serial number nameplate, located at the rear of the aerial platform, lists the following:

- Model number
- Serial number
- Aerial platform weight
- Maximum drivable height
- Maximum capacities
- Maximum number of persons permissible on the platform
- Voltage
- System pressure
- Lift pressure
- Maximum platform height
- Maximum wheel load
- Maximum wind speed
- Maximum manual force
- Maximum incline
- Year of manufacture

3.5 Component Identification

The following descriptions are for identification, explanation and locating purposes only.

3.5-1 Manual Storage Box

This weather-resistant box is mounted inside of the hydraulic/electrical compartment. It contains the operating manual, EC declaration and other important documentation. The operating manual for this make and model of aerial platform must be stored in this box.



3.5-2 Maintenance Support

The maintenance support is a safety mechanism designed to support the scissor assembly. When properly positioned, it can support the scissor assembly and empty platform. The maintenance support must be used when inspection and/or maintenance is to be performed within the lifting mechanism. To lower the maintenance support, push lock lever rearward and the maintenance support will drop. Refer to [Section 3.12](#) for procedure on how to use and store the maintenance support.



Figure 3-1. Maintenance Support



WARNING

The maintenance support must be used when inspection and/or maintenance or repairs are to be performed within the lifting mechanism. Failure to use this safety mechanism could result in death or serious injury.



WARNING

Do not reach through the scissor assembly when the platform is raised without the maintenance support properly positioned. Failure to avoid this hazard could result in death or serious injury.

3.5-3 Electrical Control Console

This auxiliary control console is located in the hydraulic/electrical compartment. It contains the following controls:

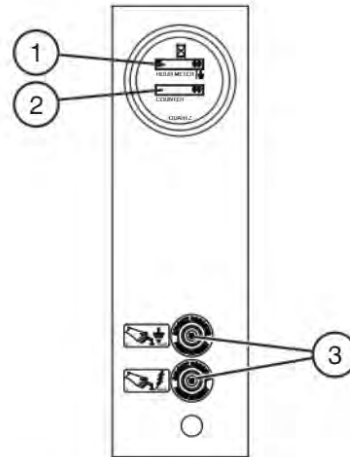

Figure 3-2. Electrical Control Console

1. **Hourmeter** - This gauge records accumulated operating time of engine.
2. **Emergency Lowering Counter** - This gauge increments each time the emergency power unit is activated while MEWP is in work mode and overloaded.
3. **Circuit Breakers** - In the event of a power overload or positive circuit grounding, the circuit breaker pops out. Push breaker back in to reset.

3.5-4 Folding Guardrail System

This system, when folded down, reduces the height of the retracted aerial platform for transporting and traveling through doorways only. Refer to [Section 3.11](#) for guardrail folding procedure.

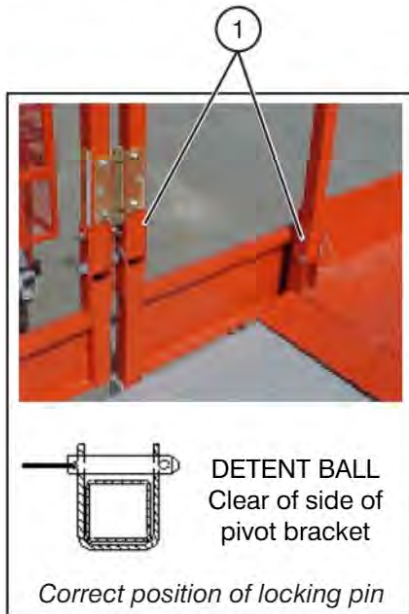

Figure 3-3. Guardrail Locking Pin



WARNING

The scissor assembly must be fully lowered before raising or lowering the guardrails.



WARNING

Before operating this aerial platform check the guardrail system for loose or missing locking pins. The guardrail system must be upright and all pins must be locked in place. Death or serious injury could result if the guardrail system is not upright or properly locked.

3.5-5 Fall Protection Anchorage

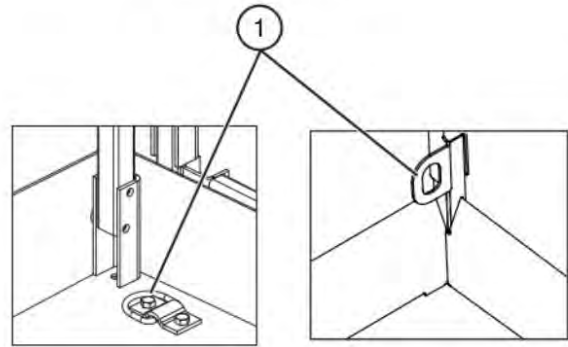

Figure 3-4. Fall Protection Anchorage

1. **Fall Protection Anchorage** - Use this as an attachment point for a fall restraint system. Do not attach anchorage connectors to any other point on the platform. Do not use this to lift, anchor, secure or support the platform or any other apparatus or material.



WARNING

The fall protection anchorage is to be used for restraint, within the limits of the platform, only.

3.6 Component Identification (Optional Equipment/Attachments)

The following descriptions are for identification, explanation and locating purposes only of optional equipment.

3.6-1 Generator/Outrigger Control Console (If Equipped)

The outrigger control console is located next to the platform control console. These switches control the outriggers' extension and retraction.

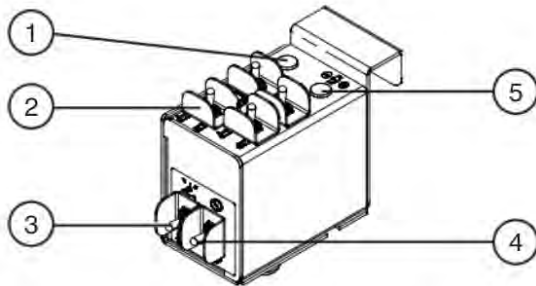

Figure 3-5. Outrigger Controls with All Options on Auxiliary Control Console

1. **Generator Switch** - This switch activates the generator.
2. **Outrigger Extend/Retract Switches** - These switches control the extension and retraction of each individual outrigger.
3. **Auto-Level Switch** - When this switch is in the "↕" extend position, each outrigger will extend and automatically adjust until the aerial platform is level. When the switch is in the "↕" retract position, the outriggers will retract.
4. **Outrigger Enable Switch** - This "⊘" outrigger enable switch, when in the extend or retract position, activates the functions on the auto-level switch and the outrigger extend/retract switches.

5. **Leveling Indicator Light** - This light functions when the auto and manual level functions are in use and illuminates to display the status of the auto-leveling outriggers. The indicator light has the following states:

- ❗ **Off:** The outriggers are fully retracted.
- ⚡❗ **Flashing Rapidly:** The outriggers are extending or retracting.
- ⚡❗ **Flashing:** Not all outrigger legs have firm ground contact or aerial platform is not level.
- ❗ **On:** The outriggers are extended and the platform is level.

3.6-2 Powered Extension Control Console (If Equipped)

This control console is mounted on one of the extension platform guardrails. It contains the following controls:

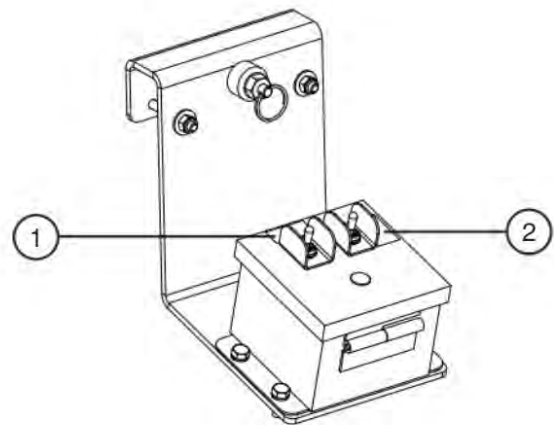

Figure 3-6. Powered Extension Control Console

1. **Enable Switch** - This switch, when activated and held, allows the extension platform extend/retract switch functions to operate.
2. **Extend/Retract Switch** - This switch, when activated, "↔" extends or "↔" retracts the powered extension platform. Refer to [Section 3.8-8](#) on how to extend/retract the powered extension platform.

3.7 Operator's Responsibility

It is the responsibility of the operator, prior to each work shift, to perform the following:

1. Visual and Daily Maintenance Inspections

- are designed to discover any damage of components before the aerial platform is put into service.
- are done before the operator performs the function tests.



WARNING

Failure to locate and repair damage, and discover loose or missing parts may result in an unsafe operating condition.

2. Function Tests

- are designed to discover any malfunctions before the aerial platform is put into service.

IMPORTANT

The operator must understand and follow the step-by-step instructions to test all aerial platform functions.

The operator should make a copy of the Operator's Checklist (see [Table 4.8](#)) and fill out the visual and daily maintenance inspections and the function tests sections while performing the items outlined in [Section 2.3](#) and [Section 2.4](#).

IMPORTANT

If damaged or any unauthorized variation from factory-delivered condition is discovered, the aerial platform must be tagged and removed from service.

Repairs to the aerial platform may only be made by a qualified service technician. After repairs are completed, the operator must perform visual and daily maintenance inspections & function tests again.

Scheduled maintenance inspections shall only be performed by qualified service technician (see [Table 4.7](#)).

3.8 Start Operation

Carefully read and completely understand the Operating Manual and all warnings and instruction labels (refer to [Section 5 - Labels](#)) on the aerial platform.



WARNING

Do not operate this aerial platform without proper authorization and training. Failure to avoid this hazard could result in death or serious injury.

Before operating this aerial platform, perform the following steps:

1. Visual and daily maintenance inspections (see [Section 2.3](#))
2. Function tests (see [Section 2.4](#))
3. Jobsite inspection
It is the responsibility of the operator to perform a jobsite inspection and avoid the following hazardous situations:
 - holes or drop-offs
 - ditches or soft fills
 - floor obstructions, bumps or debris
 - overhead obstructions
 - electrical cords, hoses and high voltage conductors
 - hazardous locations
 - inadequate surface support to withstand all load forces imposed by the aerial platform
 - wind and weather conditions
 - the presence of unauthorized personnel
 - other possible unsafe conditions



WARNING

An operator should not use any aerial platform that:

- **does not appear to be working properly.**
- **has been damaged or appears to have worn or missing parts.**
- **has alterations or modifications not approved by the manufacturer.**
- **has safety devices which have been altered or disabled.**
- **has been tagged or locked out for non-use or repair.**



Failure to avoid these hazards could result in death or serious injury.

3.8-1 To Activate Base Control Console



WARNING

Ensure that you maintain three points of contact when using the ladder to mount/dismount platform.

1. Use the ladder of aerial platform to access platform.
2. Close the gate.
3. On platform control console, pull out “” emergency stop button.
4. Insert key into off/lift/drive key switch and select “” lift position.
5. Select low/high throttle switch to “” low throttle position.



CAUTION



Do not start the engine in the high throttle position.

6. Use the ladder to dismount from platform.
7. Turn main power disconnect switch to “|” on position.
8. On base control console, pull out “” emergency stop button. A beeping sound should be audible and light should come on.



WARNING

If beeping sound is not audible and light does not come on, aerial platform must be tagged and placed out of service.

9. On engine control console, select off/on/start switch to “|” on position.
10. If diesel engine is cold, select and hold “” glow plug switch for 15 to 20 seconds or until indicator light goes off.
11. Depress and hold “” engine start pushbutton to start the engine.

3.8-2 To Raise or Lower Platform Using Base Control Console





WARNING

Be aware of overhead obstructions or other possible hazards around the aerial platform when lifting.





WARNING

Do not lower the platform unless the area below is clear of personnel and obstructions.

1. Activate base control console (refer to [Section 3.8-1](#)).
2. Insert key into off/platform/base key switch. Select and hold off/platform/base key switch to  base position.
3. Select and hold lower/neutral/raise switch to either  raise or  lower position. Release switch to stop.

Lowering Warning System - A lowering warning system automatically stops the lowering function before reaching the fully retracted position and sounds the alarm. After the operator has released the down controls and taken time to check that no person or obstructions are near the scissors, the lowering function can be reactivated.



3.8-3 To Activate Platform Control Console

1. Turn main power disconnect switch to “I” on position.
2. On engine control console, select off/on/start switch to “I” on position.
3. On base control console, pull out  emergency stop button.
4. Insert key into off/platform/base key switch. Select off/platform/base key switch to  platform position.



WARNING

Ensure that you maintain three points of contact when using the ladder to mount/dismount platform.

5. Use the ladder of aerial platform to access platform.
6. Close the gate.
7. On platform control console, insert key into off/lift/drive key switch and select  lift position.
8. Pull out  emergency stop button. A beeping sound should be audible and light should come on.



WARNING



If beeping sound is not audible and light does not come on, aerial platform must be tagged and placed out of service.

9. Select low/high throttle switch to  low throttle position.



CAUTION

Do not start the engine in the high throttle position.

10. If diesel engine is cold, depress and hold  glow plug pushbutton for 15 to 20 seconds.
11. Depress and hold  engine start pushbutton to start the engine.

3.8-4 To Raise or Lower Platform Using Platform Control Console





WARNING

Be aware of overhead obstructions or other possible hazards around the aerial platform when lifting.



WARNING

Do not lower the platform unless the area below is clear of personnel and obstructions.

1. Activate platform control console (refer to [Section 3.8-3](#)).
2. Press and hold lift  enable pushbutton, then select and hold raise/off/lower switch to either  raise or  lower position. Release switch to stop.



WARNING

To protect against unintended movement of the aerial platform, push in the emergency stop button after you have arrived at your desired location or elevation.

Lowering Warning System - A lowering warning system automatically stops the lowering function before reaching the fully retracted position and sounds the alarm. After the operator has released the down controls and taken time to check that no person or obstructions are near the scissors, the lowering function can be reactivated.

NOTE

If the tilt alarm sounds and the platform does not, or only partially raises, immediately lower the platform completely and ensure that the aerial platform is on a firm level surface.

NOTE

Some models may be equipped with an 9.1-meter lift height restriction. To raise the platform higher than 9.1 meters, the aerial platform's outriggers must be properly deployed before lifting from a fully lowered position. Refer to [Section 3.8-10](#).

3.8-5 To Drive Forward or Backward





WARNING

Be aware of blind spots when operating the aerial platform.



WARNING

Ensure that there are no personnel or obstructions in the path of travel, including blind spots.



1. Activate platform control console (refer to [Section 3.8-3](#)).
2. On platform control console, select off/lift/drive key switch to  drive position.
3. Activate and hold  enable trigger switch.
4. Push or pull controller handle forward or backward to desired speed and direction of platform travel.

- Return controller to neutral center position to stop.
Release “” enable trigger switch.

**WARNING**

To protect against unintended movement of the aerial platform, push in the emergency stop button after you have arrived at your desired location or elevation.

3.8-6 To Steer

- Activate platform control console (refer to [Section 3.8-3](#)).
- Select off/lift/drive key switch to “” drive position.
- Activate and hold “” enable trigger switch.
- Press “” rocker on top of controller handle in either direction to steer.

NOTE

Steering is not proportional. Driving and steering can be activated at the same time.

3.8-7 To Select Drive Torque

- High Torque:** Select high torque when ascending or descending grades, traveling on rough terrain or when loading or unloading aerial platform. To activate high torque, select low/high speed range switch to “” low speed (high torque) position.

**WARNING**

Aerial platform must be in fully retracted position when operated on any grade. Driving while elevated on any grade may result in death or serious injury.

- Low Torque:** Select low torque when traveling on a flat level surface. To activate low torque, select low/high speed range switch to “” high speed (low torque) position.

**WARNING**

To protect against unintended movement of the aerial platform, push in the emergency stop button after you have arrived at your desired location or elevation.

3.8-8 To Extend or Retract Manual Extension Platform

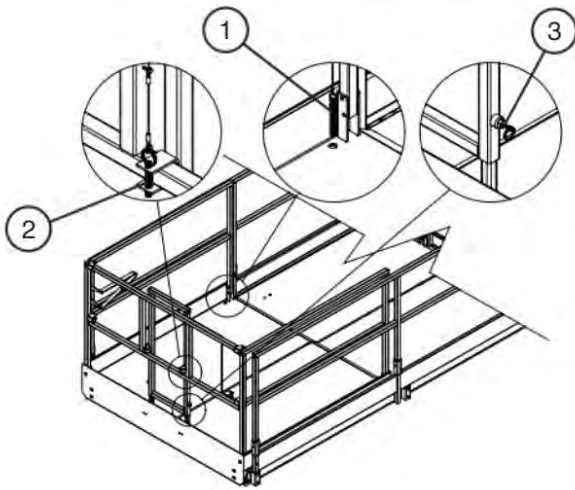







Figure 3-7. Manual Extension Platform

1. To extend/retract the manual extension platform, remove the locking pin (item 1) then remove the push bar locking pins (item 2) and rotate the push bar towards the main platform. Extend the push bar until it locks at full extension and push/pull the extension platform using the push bar.
2. Upon full extension or retraction, reinsert the locking pin on the platform (item 1) to prevent accidental movement of the manual extension platform during travel or transport.
3. When the push bar is not in use, pull the plungers (item 3) on the push bar and retract it, then rotate it back to its resting position and lock it into place with the locking pins (item 2).

3.8-9 To Extend or Retract Powered Extension Platform (If Equipped)

1. To extend the powered extension platform, ensure “” emergency stop button is pulled out.
2. On platform control console, insert key into off/lift/drive key switch and select “” lift position.
3. On the powered extension control console, select and hold “” enable switch, then push the extend/retract switch to the “” extend position. Release switch to stop.
4. To retract platform, select and hold “” enable switch, then push extend/retract switch to “” retract position. Release switch to stop.



WARNING

To protect against unintended movement of the aerial platform, push in the emergency stop button after you have arrived at your desired location or elevation.



3.8-10 Hydraulic Outriggers

These devices are mounted to the four corners of the base.

3.8-10a Before Operation





1. Move around aerial platform to check overhead clearances and ground obstructions.
2. Lower the platform completely. Refer to [Section 3.8-4](#). Outrigger controls are not functional when platform is raised.
3. Check that the supporting surface under the tires and outrigger pads is firm and capable of supporting aerial platform and rated load. Do not place outrigger pad on a street drain, manhole cover or other unsupported surface.

3.8-10b To Extend Outriggers

1. On outrigger control console, select and hold “” enable switch to provide power to outrigger circuit.
2. **Auto Extension:** Select auto-level switch to “” extend position until leveling indicator light stops flashing and remains on. Aerial platform should be level and completely supported by the outriggers.

Manual Extension: Select corresponding outrigger extend/retract switch to “” extend position until platform is fully supported by outriggers and is level. The indicator light flashes while platform is being leveled and remains on once platform is level.

The indicator light has the following states:

-  **Off:** The outriggers are fully retracted.
-  **Flashing Rapidly:** The outriggers are extending or retracting.
-  **Flashing:** Not all outrigger legs have firm ground contact or aerial platform is not level.
-  **On:** The outriggers are extended and the platform is level.

3. Ensure each outrigger pad is in firm contact over its entire surface area, with a suitable supporting surface! Make adjustments if necessary using manual outrigger controls.
4. Operate all non drive functions as described in their respective sections.

NOTE

Each outrigger pad must be in firm contact with the ground for most aerial platform functions to work.

NOTE



Drive functions are disabled if the outriggers are in any position other than fully retracted.



WARNING

If alarm sounds during operation, the aerial platform is not level or an outrigger does not have firm ground contact. Lower the platform immediately! Make the necessary adjustments to level the aerial platform.

3.8-10c To Retract Outriggers



1. Ensure platform is fully lowered.
2. On outrigger control console, select and hold “” enable switch to provide power to outrigger circuit.
3. **Auto Retraction:** Select auto-level switch to “” retract position until outriggers are fully retracted.

Manual Retraction: Select corresponding pairs of outrigger extend/retract switch to “” retract position until outriggers are fully retracted.

NOTE

Limit switches are used to protect outriggers from being damaged. If drive functions are not available, visually check to see that all outriggers are fully retracted.

3.8-11 Generator (If Equipped)**To start the hydraulic generator:**

1. On platform control console, select off/lift/drive key switch to  lift position.
2. Depress and hold  engine start pushbutton to start the engine.
3. On auxiliary control console, select hydraulic generator switch to  energized position. Engine will automatically switch to high throttle and generator will start.



To stop the hydraulic generator:

1. Select hydraulic generator switch to  off position. The generator will turn off and throttle will return to selected speed.

NOTE





Activating any lift or outrigger functions, changing the key switch setting, activating the emergency stop or an engine stall will turn off the generator. The platform may be lowered during generator operation.

3.8-12 Shutdown Procedure

1. Completely lower the platform.
2. On platform control console, push in  emergency stop button.
3. Select off/lift/drive key switch to  off position and remove key.

**WARNING**

Ensure that you maintain three points of contact when using the ladder to mount/dismount the platform.

4. Use the ladder to dismount from platform.
5. On base control console, push in  emergency stop button.
6. On off/platform/base key switch, select  off position and remove key.
7. On engine control console, select engine off/on/start switch to  off position.
8. Turn main power disconnect switch to  off position.

3.9 Refueling Procedure

This section provides the operator with the procedure on how to refuel the engine with regular fuel and install the propane cylinder.

IMPORTANT

Before using the aerial platform ensure there is enough fuel to finish the job.



WARNING

Failure to heed the following safety precautions could result in death or serious injury:

- **Use extreme caution while refueling aerial platforms.**
- **Ensure engine and all systems are turned off before refueling.**
- **Refuel aerial platform only in a well ventilated area away from open flame and other sources of ignition, authorized by your employer and supervisor.**
- **To minimize possible static electricity fires, ensure filler nozzle touches rim of filler opening to aid the dissipation of static electricity.**
- **Never try to start an aerial platform if you smell gas.**



WARNING

Do not smoke in an area where aerial platforms are stored or refueled.

3.9-1 Regular Fuel (Diesel)

1. Ensure engine and all systems are turned off and emergency stop buttons are depressed.
2. Open fuel compartment door and remove fuel cap.
3. Carefully fill the fuel tank ensuring that no spillage occurs.
4. Securely replace fuel cap.
5. Ensure there are no leaks in the fuel system.
6. Wipe up any spilled fuel.
7. Dispose of rags in an approved container.

Protection of Environment from Chemical Dangers



WARNING

Gasoline, diesel fuel, engine oil and hydraulic fluid are chemicals, which can contaminate the environment. If they are spilled during filling and reach the water, they can cause damage to the environment, e.g., death of fish. For such damage, the party responsible is liable! Therefore, gasoline, diesel fuel, engine oil or hydraulic fluid must not get into the sewage system, streams, rivers or other surface water. For that reason, immediately remove the dripped off or spilled gasoline, diesel fuel, engine oil or hydraulic fluid with appropriate means and dispose of these means according to the regulations.

3.10 Loading/Unloading

Know and heed all national, state or territorial/provincial and local rules which apply to your loading/unloading of aerial platforms.

Only qualified personnel shall operate machinery during loading/unloading.

Be sure vehicle capacity and loading equipment hoists, chains, straps, etc., are sufficient to withstand maximum aerial platform weight.

The transport vehicle must be parked on a level surface and must be secured to prevent rolling while aerial platform is being loaded/unloaded.

When it is necessary to lift the aerial platform the following conditions must be met:

- The platform must be fully lowered.
- The main power disconnect switch must be in “O” off position.
- The hydraulic/electrical and fuel compartments must be closed and securely latched.
- The extension platform must be retracted and secured.
- The platform control console must be secured to the railings or removed.
- The platform must be cleared of all personnel, tools and materials.
- The lifting/rigging must be attached to all four lifting points as illustrated in [Figure 3-8](#).

3.10-1 Lifting



WARNING
Only qualified rigger shall perform lifting.

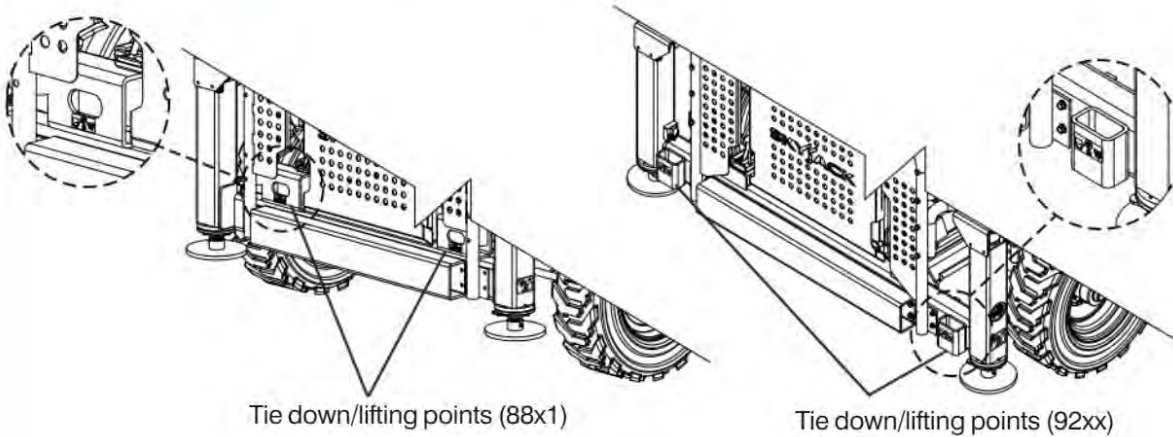

Figure 3.8. Tie Downs/Lifting Points

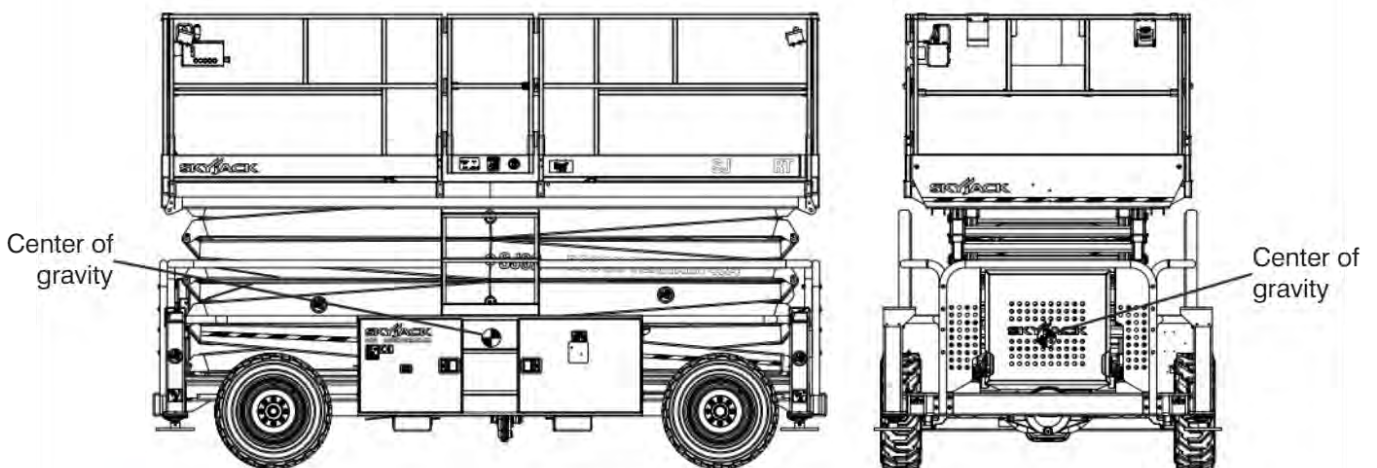

Figure 3-9. Center of Gravity

NOTE

The mass of the aerial platform is as per [Table 4.3](#). The center of gravity is approximately located in the middle of the aerial platform, front to back and side to side, as illustrated in [Figure 3-9](#). Vertically, the center of gravity is approximately just above the base chassis.

NOTE

The aerial platform can be lifted with a forklift from the sides, but Skyjack does not recommend this use, except for Models 92xx that are equipped with designated lifting pockets. See [Figure 3-10](#).

3.10-2 Driving

Before driving the aerial platform:

- Ramp or dock capacity must be sufficient to withstand maximum aerial platform weight.
- Ramp should be equipped with side guards to prevent inadvertent fall from the ramp.
- Incline must not exceed aerial platform gradeability (refer to [Table 4.3](#)).
- Aerial platform brake must be checked for proper operation.
- Aerial platform speed must be on high torque setting.

**WARNING**

When transporting, the aerial platform must be secured to the truck or trailer deck. Tie downs are available as illustrated in [Figure 3-8](#).

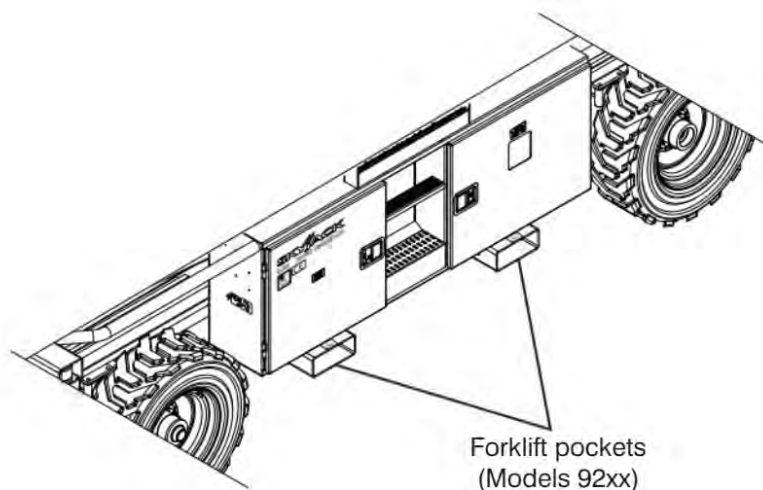

Figure 3-10. Forklift Pockets

3.11 Guardrail Folding Procedure

When folded down, the folding guardrail system reduces the overall height of the retracted aerial platform for transporting only.



WARNING

Any lowered guardrail will create a fall hazard. To avoid falling, remain away from the sides of the platform while raising or lowering the guardrails.

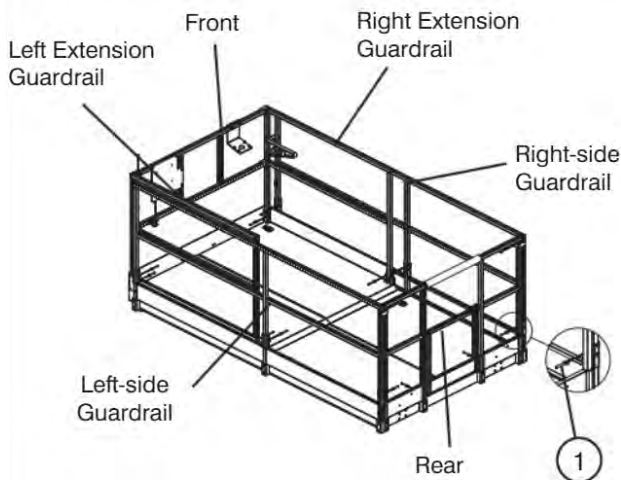

Figure 3-11. Folding Guardrail System

1. **Guardrail Locking Pin with Lanyard** - This pin is used to lock the guardrail in place.



WARNING

Before operating this aerial platform check the guardrail system for loose or missing locking pins. The guardrail system must be upright and all pins must be locked in place. Death or serious injury could result if the guardrail system is not upright or properly locked.



WARNING

The scissor assembly must be fully lowered before raising or lowering the guardrails.

To fold the guardrail system down:

1. Ensure aerial platform is on level ground and all extension platforms are fully retracted.

2. Turn main power disconnect switch to "O" off position.



WARNING

Ensure that you maintain three points of contact when using the ladder to mount/dismount platform.

3. Use the ladder of aerial platform to access platform.
4. Close the gate.



WARNING

Any lowered guardrail will create a fall hazard. Remain away from the sides of the platform while raising or lowering the guardrails to avoid falling.

5. Remove the platform control console and outrigger control console (if equipped) and lay it down on the platform.
6. Fold guardrails down in the following order: rear, front, left extension, right extension, left-side and right-side (refer to [Figure 3-11](#)).
7. Remove all the locking pins on the rear guardrail and fold the guardrail down.
8. If there is a manual extension, remove all locking pins on the push bar and fold it down.
9. Remove all the locking pins that secured the front guardrail to the left extension guardrail then swing it towards the right extension and lock it in place.
10. Remove all the locking pins on the left extension and fold it down.
11. Remove all the locking pins on the right extension guardrail and fold it down.
12. Remove all the locking pins on the left-side guardrail and fold it down.
13. Remove all the locking pins on the right-side guardrail and fold it down.

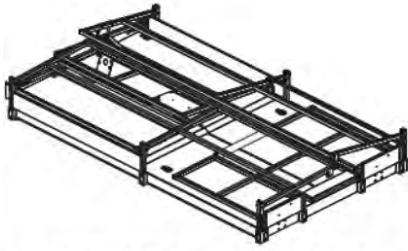

Figure 3-12. All Guardrails Folded Down

To raise the guardrail system up:



WARNING

The scissor assembly must be fully lowered before raising or lowering the guardrails.

1. Ensure aerial platform is on level ground.
2. Turn main power disconnect switch to “O” off position.



WARNING

Ensure that you maintain three points of contact when using the ladder to mount/dismount platform.

3. Use the ladder of aerial platform to access platform.



WARNING

Any lowered guardrail will create a fall hazard. Remain away from the sides of the platform while raising or lowering the guardrails to avoid falling.



WARNING

Ensure that the detent ball of each locking pin is all the way through and each spring clip is fully inserted into the pin hole.

4. Raise the guardrails up in the following order: right-side, left-side, right extension, left extension, front and rear.
5. Swing the right-side guardrail up and lock it in place by inserting all locking pins.
6. Swing the left-side guardrail up and lock it in place by inserting all locking pins.

7. Swing the right extension guardrail up and lock it in place by inserting all locking pins on the right extension.
8. Swing the left extension guardrail up and lock it in place by inserting all locking pins.
9. Remove the locking pins and swing the front guardrail forward. Lock it in place by inserting all locking pins.
10. If there is a manual extension, swing push bar up and lock in place by inserting all locking pins.
11. Swing the rear guardrail up then lock it in place by inserting all locking pins.
12. Mount the platform control console and outrigger control console (if equipped) at the front right of the platform. Lock them in place.



WARNING

Before operating this aerial platform check the guardrail system for loose or missing locking pins. The guardrail system must be upright and all pins must be locked in place. Death or serious injury could result if the guardrail system is not upright or properly locked.

3.12 Maintenance Support Procedure

This section provides the operator with procedure regarding deployment and storage of maintenance support.

The maintenance support is a safety mechanism designed to support the scissor assembly. When properly positioned it can support the scissor assembly and empty platform. The maintenance support must be used when inspection and/or maintenance is to be performed within the lifting mechanism.



WARNING

The maintenance support must be used when inspection and/or maintenance or repairs are to be performed within the lifting mechanism. Failure to use this safety mechanism could result in death or serious injury.



Figure 3-13. Maintenance Support

To Deploy the Maintenance Support

1. Remove all material from platform.
2. Raise platform until there is adequate clearance to swing down maintenance support (item 1).
3. Push latch lever rearward.
4. Swing maintenance support down from storage bracket into a vertical position.
5. Remove hands and arms from scissors area.
6. Lower platform until bottom end of maintenance support contacts the labeled cross bar and scissors are supported by maintenance support.
7. Turn main power disconnect switch to "O" off position.

To Store the Maintenance Support

1. Turn main power disconnect switch to "I" on position.
2. Raise platform until there is adequate clearance to swing up the maintenance support.
3. Swing bar fully up into storage latch.
4. Lower the platform.



WARNING





Do not reach through the scissor assembly when the platform is raised without the maintenance support properly positioned. Failure to avoid this hazard could result in death or serious injury.

Table 4.1 Standard and Optional Features

Models	Full-Size Rough Terrain			
	8831	8841	9241	9250
STANDARD EQUIPMENT				
21.6 kW (29 hp) Kubota D1305 diesel water-cooled engine	*	*	*	*
4WD	*	*	*	*
Access ladders and half-height spring-hinged gates at both sides of platform	*	*	*	*
Base control console	*	*	*	*
Color coded and numbered wiring system	*	*	*	*
Diamond pattern, all steel platform deck construction	*	*	*	*
Disc brake system on rear axle	*	*	*	*
Fall Protection Anchorage(s)	*	*	*	*
Flashing light and descent alarm	*	*	*	*
Forklift pockets			*	*
Front and rear mounted 1.2 m rollout extension platform	*	*		
Front mounted 1.4 m roll out extension platform				
Front and rear mounted 1.5 m powered extension platform			*	*
Hinged railing system with 15.25 cm (6 in.) toe boards	*	*	*	*
Hourmeter	*	*	*	*
Hydraulic oil level and temp. indicators	*	*	*	*
Lockable cabinets with swing-out door	*	*	*	*
Lowering warning system	*	*	*	*
Manual brake release	*	*	*	*
Maximum drive height	Full Height	Full Height	Full Height	9.1 m
Operator horn	*	*	*	*
Overload sensing system	*	*	*	*
Platform control console	*	*	*	*
Rollout engine tray	*	*	*	*
Scissor guards	*	*	*	*
Self-centering scissors design	*	*	*	*
Tie downs/lifting eyes	*	*	*	*
Tie-down points	*	*	*	*
Tilt alarm with drive/lift cut out	*	*	*	*
Type #6 Foam-filled tires	*	*	*	*
Wiring for AC outlet on platform	*	*	*	*
OPTIONAL EQUIPMENT				
3500 watt hydraulic generator	*	*	*	*
All motion audible alarm	*	*	*	*
Comprehensive parts/operating and service manual	*	*	*	*
Front and rear mounted 1.2 m powered extension platform	*	*		
Front mounted 1.4 m powered extension platform				
Full-height spring-hinged gates at both sides of platform	*	*		
Grip lug, foam filled non marking tires	*	*	*	*
Hinged railing system				
Independent/auto leveling outriggers	STD	STD	STD	STD
Rotating amber beacon	*	*	*	*
Shop air line to platform	*	*	*	*

139AF-CE

Table 4.2 Owner's Annual Inspection Record

										
 Model Number: _____ Serial Number: _____										
*			20__	20__	20__	20__	20__	20__	20__	20__
**			<small>SKYJACK</small>							

1001AB

This decal is located on the scissor assembly. It must be completed after an annual inspection has been completed. Do not use the aerial platform if an inspection has not been recorded in the last 6 months.



	Pictorial	Description
*		Inspection Date
**		Inspector Signature

Table 4.3 Specifications and Features

MODEL	8831	8841	9241	9250
Weight *	5684 kg	6173 kg	6718 kg	7407 kg
Overall width	2.2 m		2.34 m	
Overall length	3.7 m		4.55 m	
Platform Size (inside)	1.7 m x 3.5 m		1.85 m x 4.39 m	
Height				
Working Height	11.6 m	14.5 m	14.5 m	17.2 m
Platform Elevated Height	9.6 m	12.5 m	12.5 m	15.2 m
Stowed Platform Height	1.5 m	1.8 m	1.68 m	2 m
Drive Height	Full			9.1 m
Standard Operating Times				
Lift Time (Rated Load)	52 s	56 s	62 s	64 s
Lower Time (Rated Load)	47 s	53 s	59 s	86 s
Chassis				
Normal Drive Speed	4.2 km/h		3.8 km/h	
Elevated Drive Speed	0.35 km/h		0.72 km/h	
Gradeability (Ramp Angle)	30%			
Tires (Solid Rubber)	Refer to Table 4.6 for tire specification and usage.			
Hydraulic Oil				
Type	ATF Dexron III			
Tank Capacity (Liters)	75.71		67.38	
Engine (RPM)				
Engine Type	Kubota D1305			
RPM Settings	1400 (Low) / 2800 (High)			
Fuel Type	Diesel			
Fuel Tank Capacity (Liters)	49.21		64.35	
Engine Oil Type	SAE 10W-30			
Recommended Alternative Engine Oil	10W-30, API Service Designation CG-4, CF-4, CF, CD, SH			
Engine Oil Capacity (Liters)	6			
Coolant Type	Anti-freeze / Water			
Coolant Capacity (Liters)	4			
Sound Pressure Level (ISO 3744)	67dB(A)			
Guaranteed Maximum Sound Power Level (ISO 4871)	103dB			
Note: Whole body vibration on platform does not exceed 0.5 m/s ² .				

140AH-CE

* Weights are approximate; refer to serial nameplate for specific weight. Values shown for models 8831, 8841 are for standard 4WD aerial platforms on foam filled tires and two rollout extension platforms. Values shown for models 9241 & 9250 are for standard 4WD on foam tires with two powered extension platforms.

Table 4.4 Maximum Platform Capacities (Evenly Distributed)

MODEL		Total		First Extension		Second Extension		Maximum Wind Speed	Tilt Cutout Setting (Degrees)	Tilt Cutout Setting (Outriggers) (Degrees)
		Capacity	Number of Occupants	Capacity	Number of Occupants	Capacity	Number of Occupants			
8831	Two Extension Platform	908 kg	6	227 kg	2	227 kg	2	12.5 m/s	2.5 x 4.5	1.5 x 1.5
8841	Two Extension Platform	681 kg	5	227 kg	2	227 kg	2	12.5 m/s	2.5 x 4.5	1.5 x 1.5
9241	Two Extension Platform	681 kg	5	227 kg	2	227 kg	2	12.5 m/s	2.5 x 4.5	1.5 x 1.5
9250	Two Extension Platform	681 kg	5	227 kg	2	227 kg	2	12.5 m/s	2.5 x 4.5	1.5 x 1.5

141AD-CE

NOTE:

Occupants and materials are not to exceed rated load.
 Capacities listed are for standard machines equipped with #6 tires.
 Refer to capacity label at sides of platform for additional information and for models equipped

Table 4.5 Floor Loading Pressure

MODEL		Total Aerial Platform Weight	Total Aerial Platform Load		
			WHEEL	LCP **	OUP **
		kg	kg	kPa	kg/m ²
8831	min*	5536	2214	1254	719
	max*	6788	2715	1399	882
8831 Outrigger Pads	min*	5831	2333	451	690
	max*	6788	2715	525	804
8841	min*	6174	2448	1312	795
	max*	7145	2858	1455	928
8841 Outrigger Pads	min*	6174	2566	496	759
	max*	7145	2858	553	846
9241	min*	6718	2687	1408	887
	max*	7448	2979	1495	893
9241 Outrigger Pads	min*	6718	2687	520	700
	max*	7448	2979	577	705
9250	min*	7407	2963	1490	969
	max*	8137	3255	1576	975
9250 Outrigger Pads	min*	7407	2963	573	765
	max*	8137	3255	630	770

142AD-CE

- * **min** - Total aerial platform weight with no options
- max** - Aerial platform weight + all options + capacity
- ** **LCP - Locally Concentrated Pressure** is a measure of how hard the aerial platform presses on the areas in direct contact with the floor. The floor covering (tile, carpet, etc.) must be able to withstand more than the indicated values above.
- OUP - Overall Uniform Pressure** is a measure of the average load the aerial platform imparts on the whole surface directly underneath it. The structure of the operating surface (beams, etc.) must be able to withstand more than the indicated values above.

NOTE:

The LCP or OUP that an individual surface can withstand varies from structure to structure and is generally determined by the engineer or architect for that particular structure.

Floor Loading Pressure

Locally Concentrated Pressure (LCP):

$$\text{Foot Print Area} = \text{Length} \times \text{Width}$$

$$= \pi r^2$$

$$\text{LCP} = \frac{\text{Weight of Aerial Platform} + \text{Capacity}}{\text{Foot Print Area} \times 4 \text{ (Tires)}}$$

Overall Uniform Pressure (OUP):

$$\text{Base Area} = \text{Length} \times \text{Width}$$

$$\text{OUP} = \frac{\text{Weight of Aerial Platform} + \text{Capacity}}{\text{Base Area}}$$

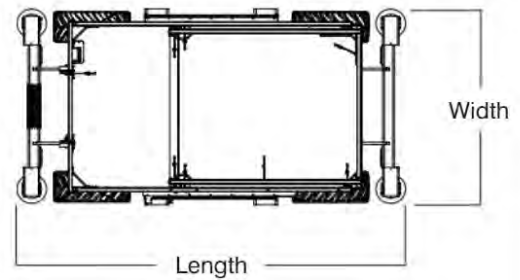
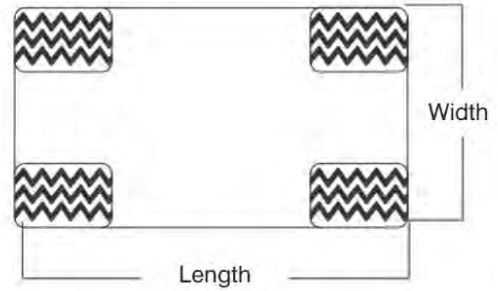
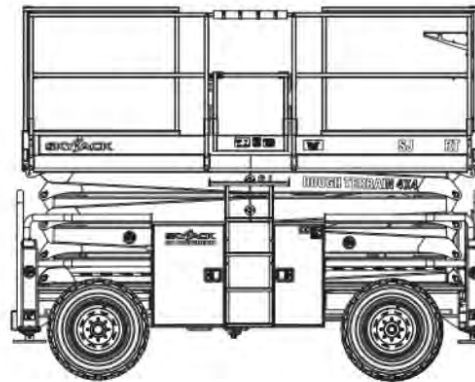
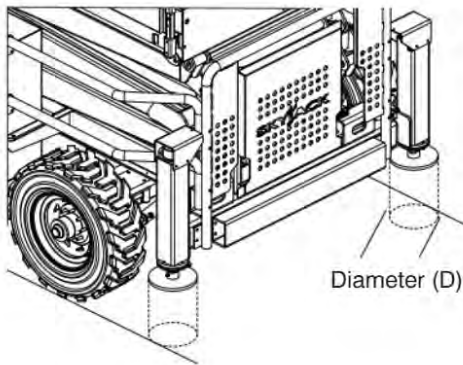
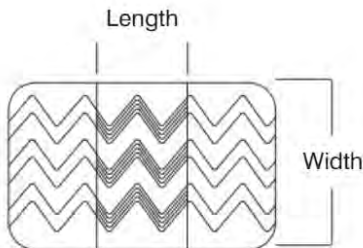
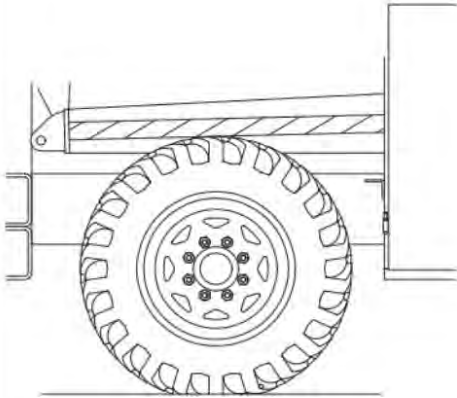

Table 4.6 Tire Specifications



WARNING

Tires must be checked by end user on a daily basis. Do not intermix tires of different types on one aerial platform. Use only tires of type originally supplied.

Tire Size		Fill Specification			Usage*			
		Fill Type	Ply Rating	Pressure (Factory) (kPa)	FULL SIZE			
					883 I	884 I	924 I	9250
#6F	10-16.5 CARLISLE US LOADER	Foam	10	N/A	S	S	S	S
#6F	10-16.5 OTR OUTRIGGER (Non-Marking)		10	N/A	O	O	N/A	N/A

143AC-CE

* Usage: (S)tandard Or (O)ptional
(N/A) Not Available

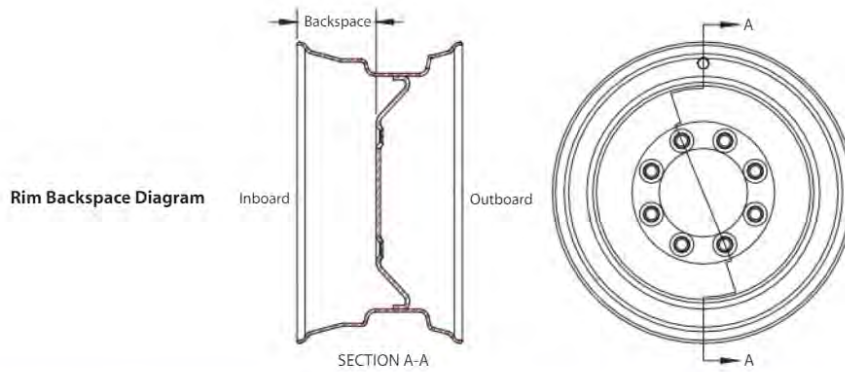

Rim Size	Backspace			
	883 I	884 I	924 I	9250
#6F	121 mm	121 mm	95mm	95 mm

144AC-CE



WARNING

Intermixing tires of different types or using tires of types other than those originally supplied with this equipment can adversely affect stability. Therefore, replace tires only with the exact Skyjack-approved type. Failure to operate with matched approved tires in good condition may result in death or serious injury.

General Maintenance

Before attempting any repair work, disconnect battery by turning main power disconnect switch to “○” off position. Preventive maintenance is the easiest and least expensive type of maintenance.

Table 4.7 Maintenance and Inspection Schedule

Frequency	Daily	3 months or 150 hours	Yearly	Frequency	Daily	3 months or 150 hours	Yearly
Visual and Daily Maintenance Inspections				Maintenance Support	A		
Labels	A			Scissor Assembly	A		
Electrical	A			Scissor Bumpers	A		
Limit Switches	A			Lift Cylinder(s)	A		
Hydraulic	A			Base			
Emergency Lowering Access Rod (All models except 9250)	A			Base Weldment	A		
Hydraulic/Electrical Compartment				Wheel/Tire Assembly	A		B*†
Main Power Disconnect Switch	A			Drive Axle	A		
Base Control Switches	A			Steer Cylinder Assembly	A		
Battery	A			Tie Rod	A		
Manifolds	A			Ladder	A		
Electrical Panel	A			Outriggers	A		
Load/Tilt Sensor	A			Manuels	A		
Hydraulic Tank (Models 92xx)	A			Function Tests			
Hydraulic Oil	A			Platform Control Console			
Hydraulic/Fuel Compartment				Test Emergency Stop	A		
Hydraulic Tank (Models 88xx)	A			Test Lift Enable	A		
Hydraulic Oil (Models 88xx)	A			Test Platform Raising/Lowering	A		
Fuel Tank	A			Test Enable Trigger Switch	A		
Fuel Leaks	A		B*†	Test Steering	A		
Engine Compartment				Test Horn	A		
Engine Control Console	A			Test Driving	A		
Radiator	A			Test Brake	A		
Muffler and Exhaust	A			Test Speed Limit	A		
Engine Tray	A			Test Lowering Warning	A		
Hydraulic Pump	A			Test Powerdeck Enable (If Equipped)	A		
Engine Oil Level	A			Test Extension Platform(s) (If Equipped)	A		B*†
Engine Air Filter	A			Test Emergency Powered Extension Platform Retraction Switch (Models 9250)	A		
Fuel Leaks	A			Base Control Console			
Platform Assembly				Test Emergency Stop	A		
Fall Protection Anchorage(s)	A			Test Base Lift Enable	A		
AC Outlet on Platform	A			Test Lower/Neutral/Raise Switch	A		
Platform Control Console	A			Test Emergency Lowering (Models 88xx & 9241)	A		
Powered Extension Control Console (If Equipped)	A			Test Emergency Lowering (Model 9250)	A		
Lifting Mechanism				Test Main Power Disconnect Switch	A		
Scissor Guards	A			Test Outriggers	A		
Sliders	A						

60603AH-CE

- A** - Perform Visual and Daily Maintenance Inspections & Functions Test. Refer to Section 2.3 and Section 2.4 of this manual.
- B** - Perform Scheduled Maintenance Inspection. Refer to Service & Maintenance manual.
- *** - Maintenance must be performed only by trained and competent personnel who are familiar with mechanical procedures.
- †** - Refer to Skyjack's website @ www.skyjack.com for latest service bulletins prior to performing quarterly or yearly inspection.



WARNING

Use original or manufacturer-approved parts and components for aerial platform.

Table 4.8 Operator's Checklist



Serial Number: _____
 Model: _____
 Hourmeter Reading: _____ Operator's Name (Printed): _____
 Date: _____
 Time: _____ Operator's Signature: _____

Each item shall be inspected using the appropriate section of the Skyjack operating manual.
 As each item is inspected, check the appropriate box.

- P** - PASS
- F** - FAIL
- R** - REPAIRED
- NA** - NOT APPLICABLE

INSPECTION FREQUENCY

- FREQUENTLY
- DAILY
- ANNUALLY
- BI-ANNUALLY

	N/A	P	F	R		N/A	P	F	R
Visual and Daily Maintenance Inspections					Maintenance Support				
Labels					Scissor Assembly				
Electrical					Scissor Bumpers				
Limit Switches					Lift Cylinder(s)				
Hydraulic					Base				
Emergency Lowering Access Rod (All Models Except 9250)					Base Weldment				
Hydraulic/Electrical Compartment					Wheel/Tire Assembly				
Main Power Disconnect Switch					Drive Axle				
Base Control Switches					Steer Cylinder Assembly				
Battery					Tie Rod				
Manifolds					Ladder				
Electrical Panel					Outriggers				
Load/Tilt Sensor					Manuals				
Hydraulic Tank (Models 92xx)					Function Tests				
Hydraulic Oil					Platform Control Console				
Hydraulic/Fuel Compartment					Test Emergency Stop				
Hydraulic Tank (Models 88xx)					Test Lift Enable				
Hydraulic Oil (Models 88xx)					Test Platform Raising/Lowering				
Fuel Tank					Test Enable Trigger Switch				
Fuel Leaks					Test Steering				
Engine Compartment					Test Horn				
Engine Control Console					Test Driving				
Radiator					Test Brake				
Muffler and Exhaust					Test Speed Limit				
Engine Tray					Test Lowering Warning				
Hydraulic Pump					Test Powerdeck Enable (If Equipped)				
Engine Oil Level					Test Extension Platform(s) (If Equipped)				
Engine Air Filter					Test Emergency Powered Extension Platform Retraction Switch (Model 9250)				
Fuel Leaks					Base Control Console				
Platform Assembly					Test Emergency Stop				
Fall Protection Anchorage(s)					Test Base Lift Enable				
AC Outlet on Platform					Test Lower/Neutral/Raise Switch				
Platform Control Console					Test Emergency Lowering (Models 88xx & 9241)				
Powered Extension Control Console (If Equipped)					Test Emergency Lowering (Model 9250)				
Lifting Mechanism					Test Main Power Disconnect Switch				
Scissor Guards					Test Outriggers				
Sliders									

60604AG-CE

Note:
 Make a copy of this page or visit the Skyjack web site:
www.skyjack.com for a printable copy.

Label Legend

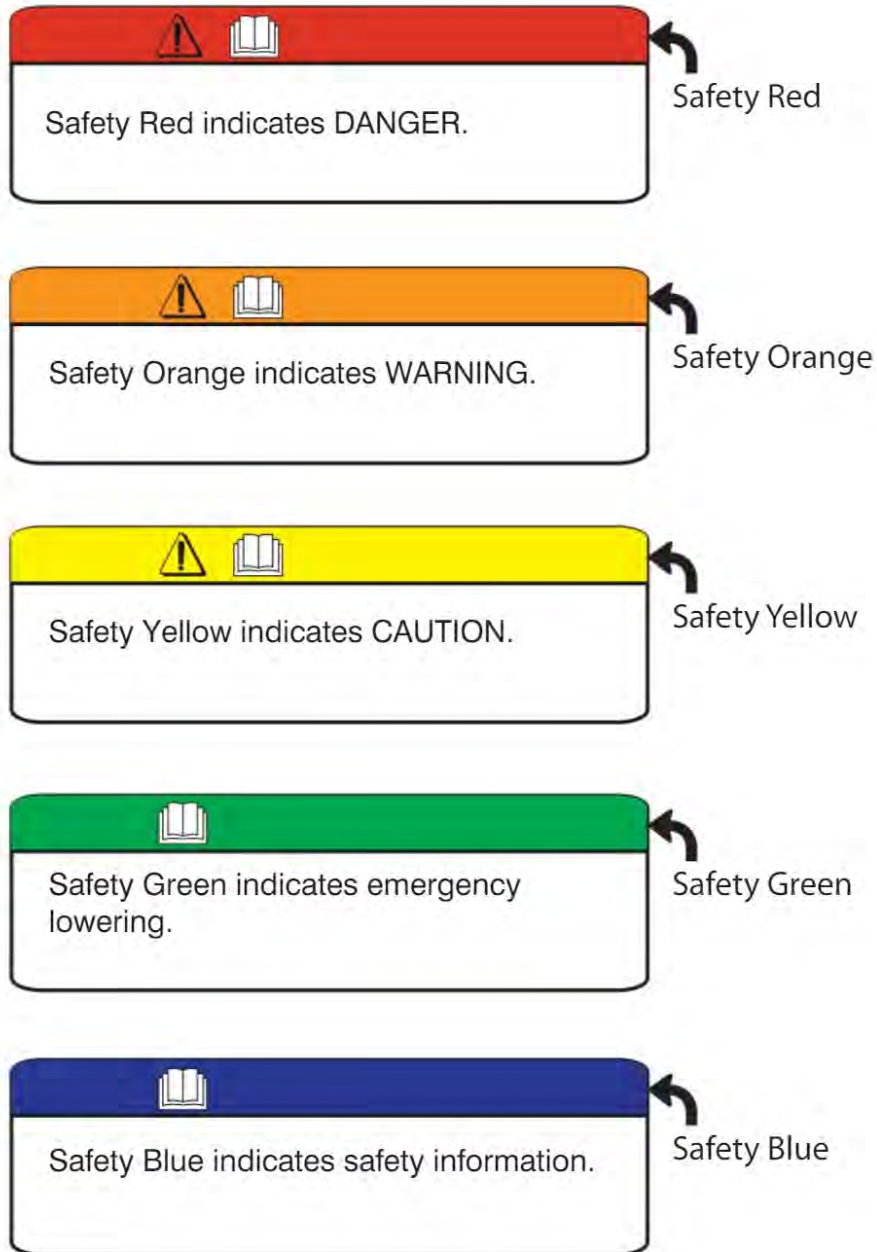

Models 8831 & 8841

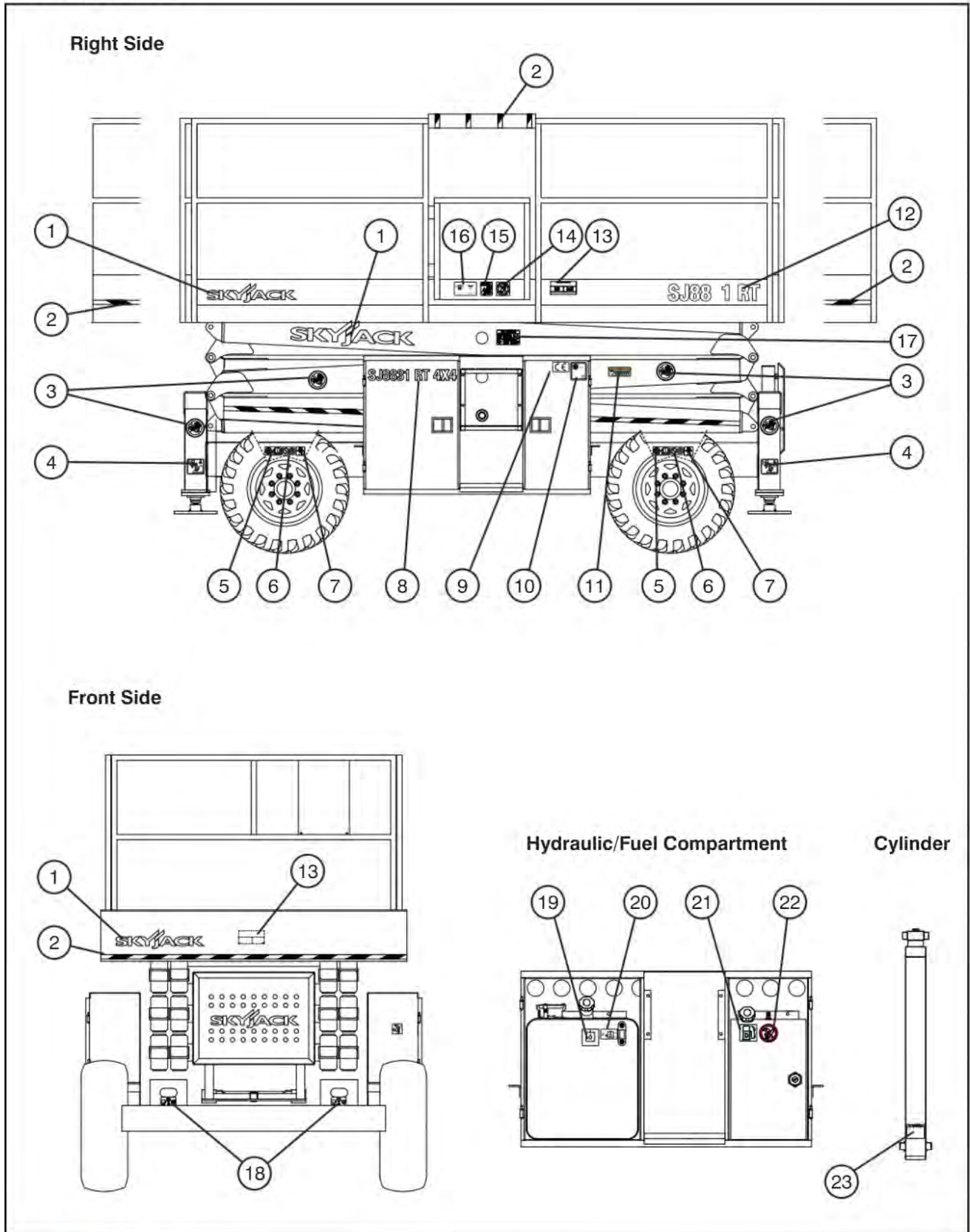

Left Side

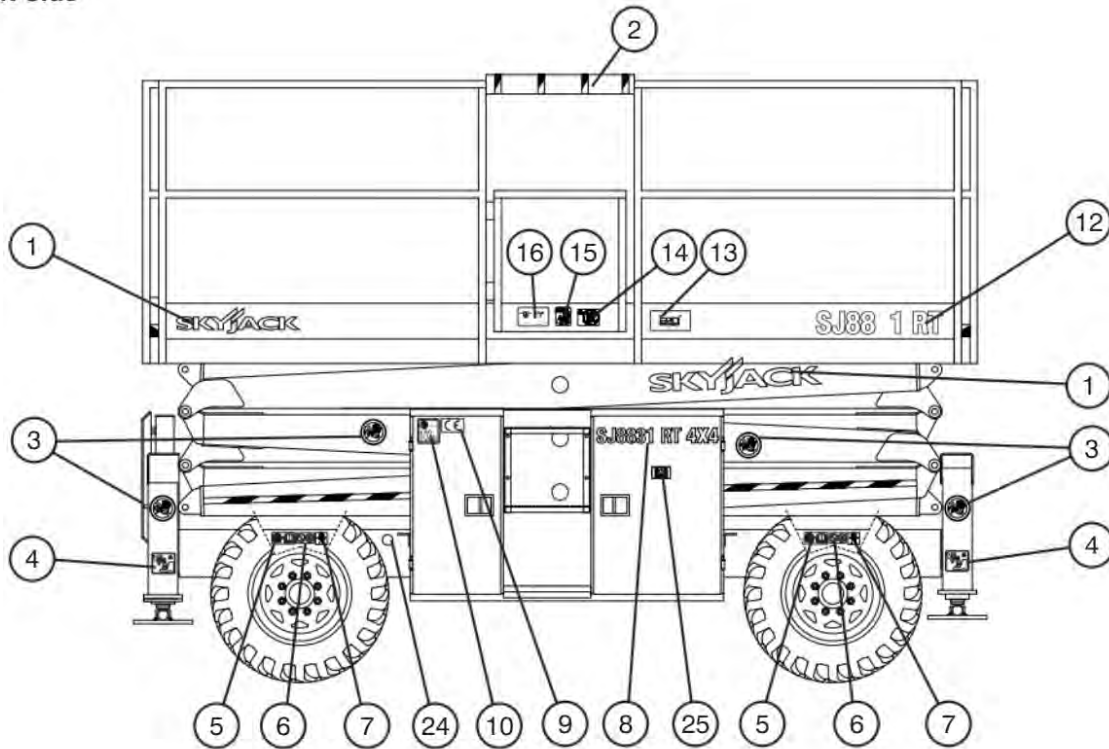

Back Side

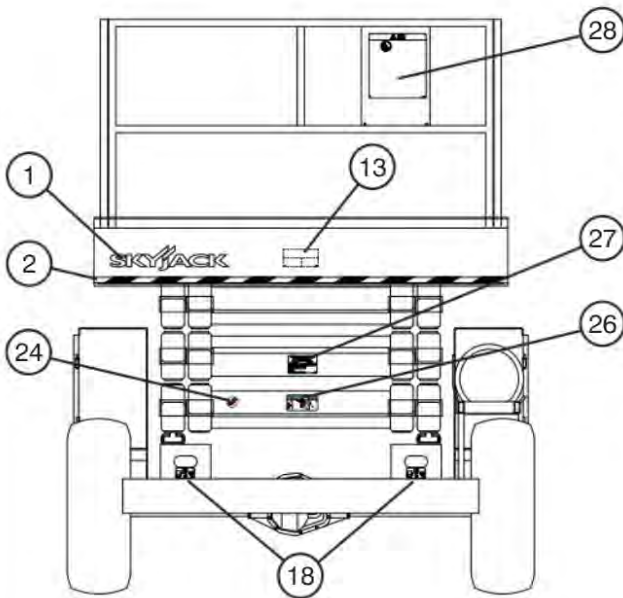

Electrical Panel and Hydraulic/Fuel Compartment

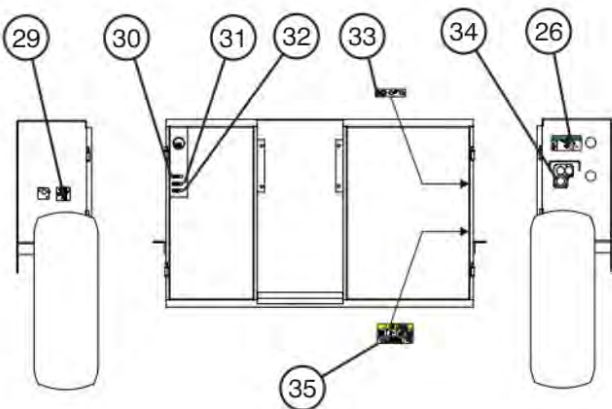

Model 92xx

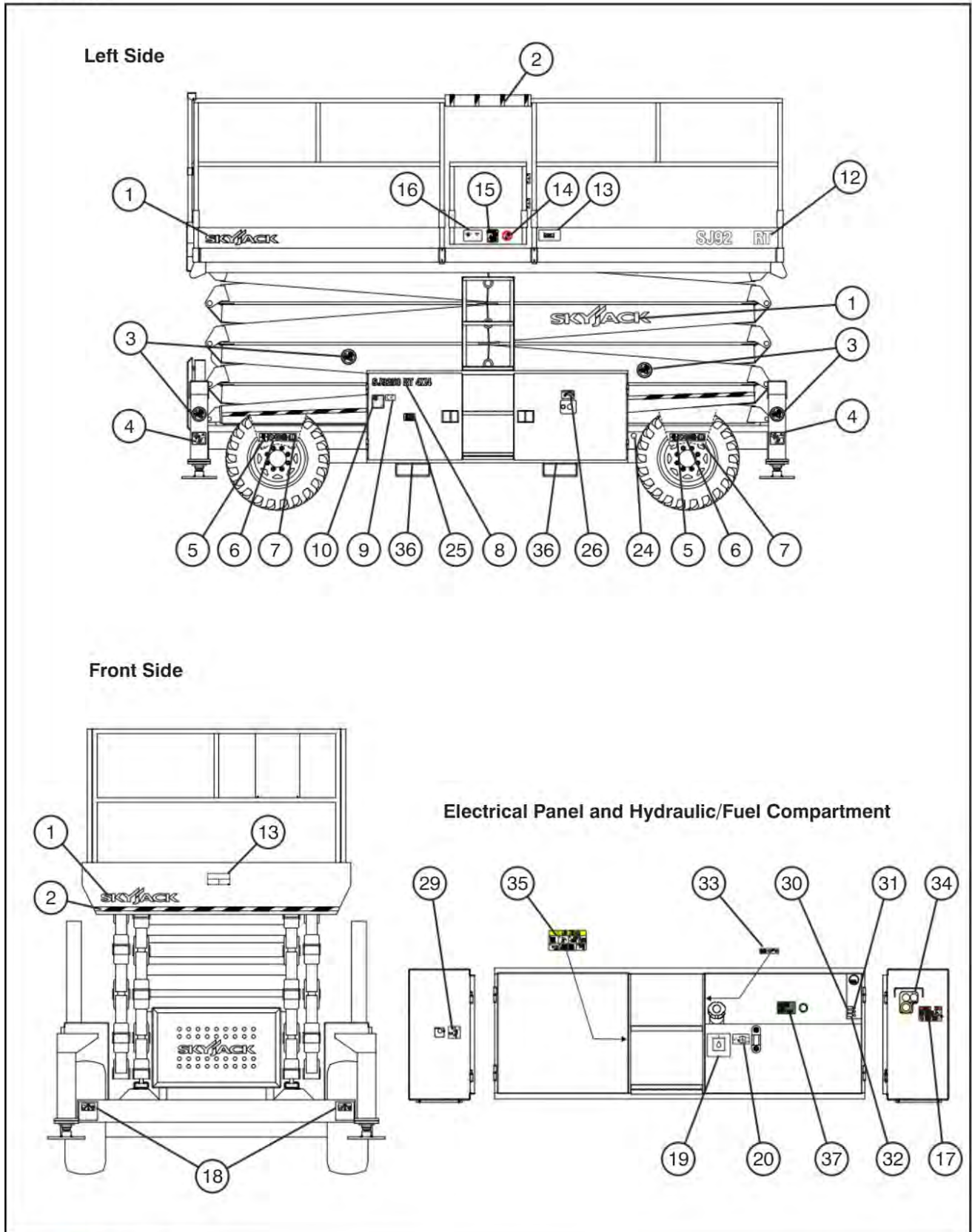

Right Side

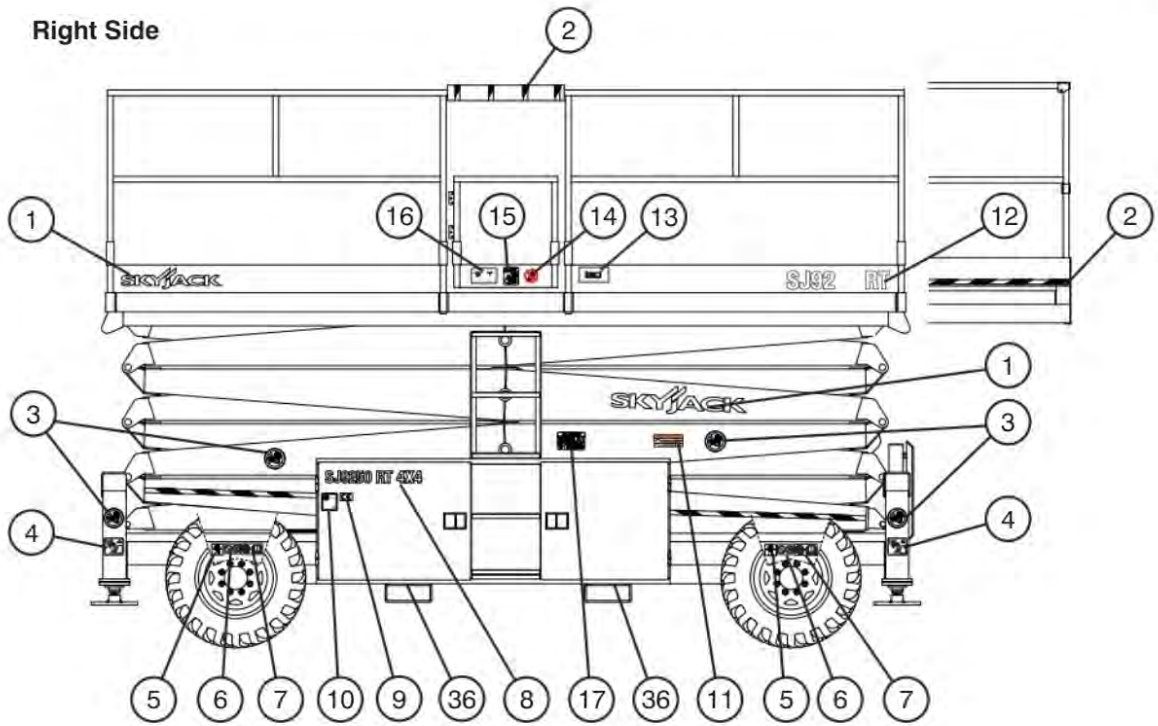

Back Side

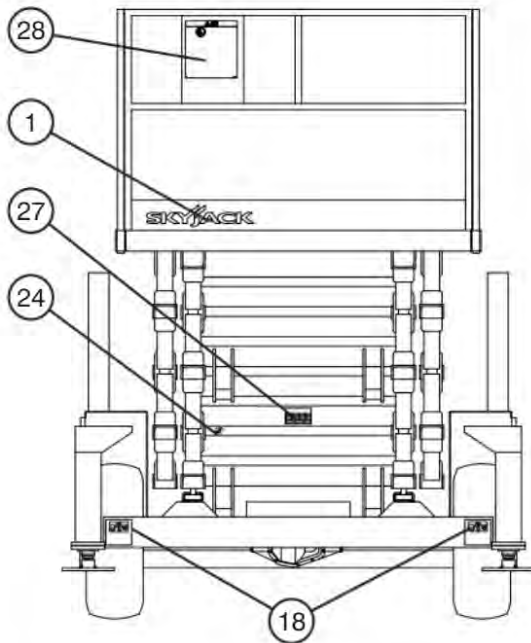



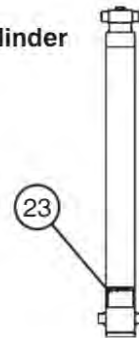



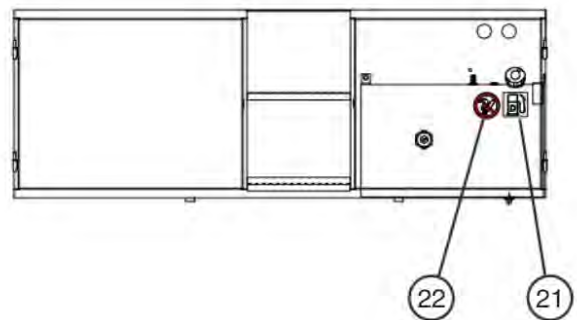







Cylinder







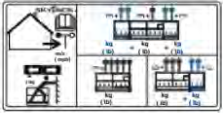

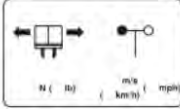
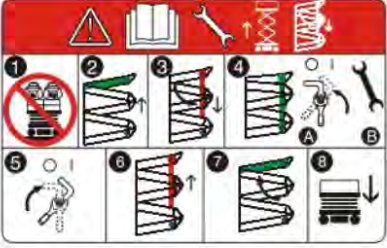

Fuel Compartment



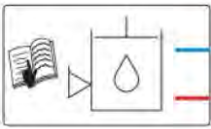





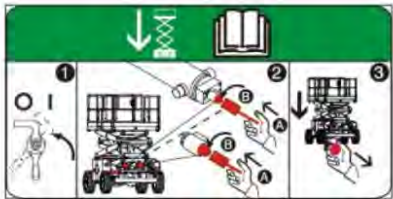







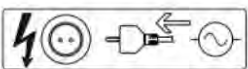

No.	Label Pictorial	Description
1		<p>Skyjack Logo</p> <p>Skyjack</p>
2		<p>Caution Tape Stripe</p> <p>Caution stripe</p>
3		<p>Keep Clear</p> <p>Keep clear. Stay away from aerial platform when in operation.</p>
4		<p>Crushing Hazard</p> <p>Danger - Crushing hazard</p>
5		<p>Wheel Load*</p> <p>Indicates rated wheel load. *Wheel load will vary with each model.</p>
6		<p>Wheel Specifications</p> <p>Refer to manual for wheel type, offset, pressure and torque.</p>
7		<p>Foam-filled Tire</p> <p>Indicates foam-filled tire only.</p>

No.	Label Pictorial	Description
8		<p>Model Number*</p> <p>Product Identifier *Model number will vary, may not be as shown.</p>
9		<p>“CE”</p> <p>CE rating mark</p>
10		<p>Sound Power Level</p> <p>Guaranteed maximum sound power level</p>
11		<p>Annual Inspection</p> <p>Ensure that work platform has received annual inspection prior to operation.</p>
12		<p>Model Number*</p> <p>Product Identifier *Model number will vary, may not be as shown.</p>
13		<p>Platform Capacity*</p> <p>Rated work load in each configuration is as shown. *Platform capacity varies over different aerial platforms.</p>
14		<p>No Jewelry</p> <p>Caution. Do not wear jewelry.</p>







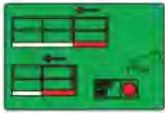

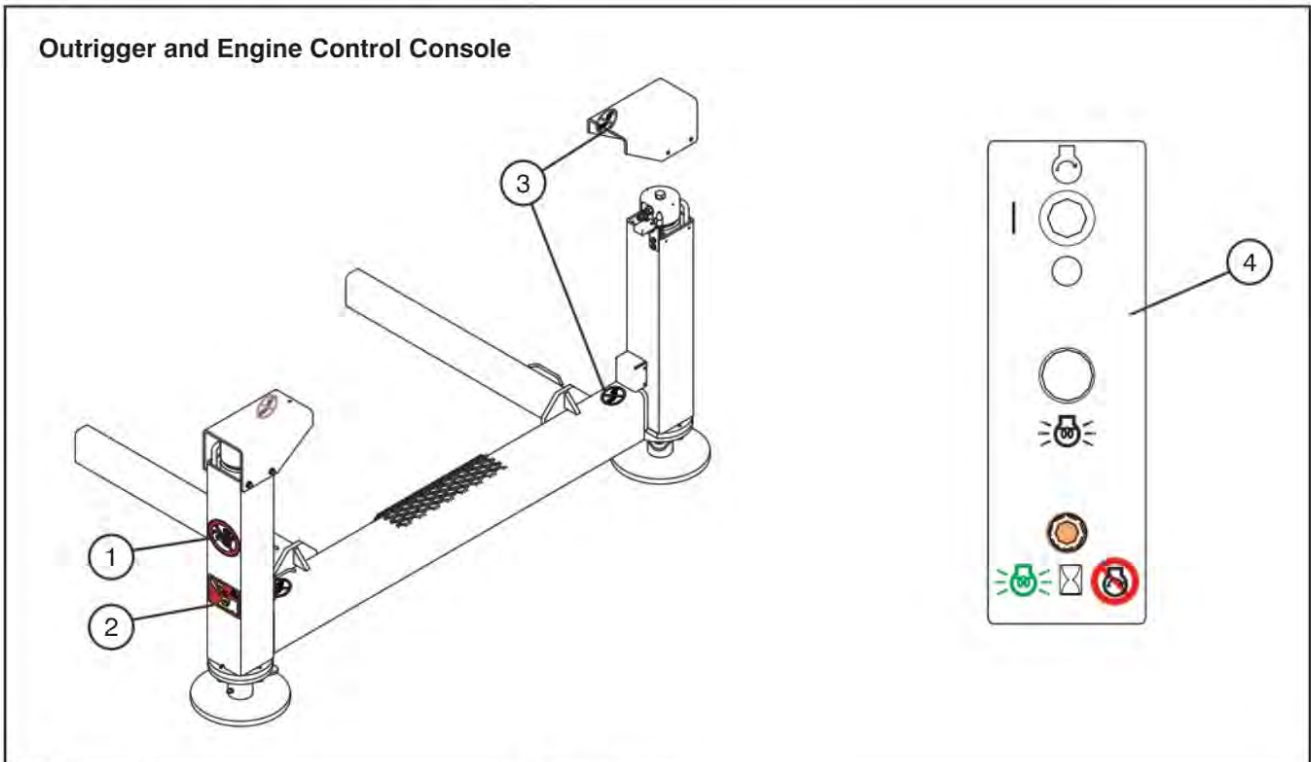

No.	Label Pictorial	Description
15		<p>Operator's Daily Inspection</p> <p>Refer to the operating manual. Perform visual inspection and function tests at the beginning of each shift. Refer to Table 4.7 Maintenance and Inspection Schedule.</p>
16		<p>Horizontal Load Rating*</p> <p>Apply no more than the indicated side load. Operate below indicated wind speed only. *Rating will change over varying units.</p>
17		<p>How to engage maintenance support for inspection or maintenance.</p> <p>Refer to operating manual.</p> <ol style="list-style-type: none"> 1. Remove all material from platform. 2. Raise platform until there is adequate clearance to swing down maintenance support. 3. Swing maintenance support down from storage bracket into a vertical position. Lower platform until the bottom end of maintenance support rests on the lower cross bar. 4. Maintenance support is now secured. <ul style="list-style-type: none"> (A) Turn main power disconnect switch to off position. (B) Perform inspection/maintenance. 5. Turn main power disconnect switch to on position. 6. Raise platform until there is adequate clearance to swing up maintenance support. 7. Swing maintenance support up and place into storage bracket. 8. Ensure platform is fully lowered.
18		<p>Lift and Tie Down Points</p> <p>Only use these points for lifting or tying down.</p>
19		<p>Hydraulic Oil ATF Dexron III</p> <p>Replace hydraulic fluid with ATF Dexron III only.</p>

No.	Label Pictorial	Description
20		<p>Hydraulic Oil Level</p> <p>Indicates minimum/maximum oil level.</p>
21		<p>Diesel</p> <p>Use diesel fuel only.</p>
22		<p>No Smoking</p> <p>Do not smoke near this location.</p>
23		<p>Orifice Installed</p> <p>Orifice installation warning</p>
24		<p>Warning - Do Not Alter</p> <p>Do not alter or disable limit switches or other safety devices.</p>
25		<p>Manual Storage Box</p> <p>Indicates location of operating manual.</p>
26		<p>Emergency Lowering Procedure</p> <p>Refer to operating manual.</p> <ol style="list-style-type: none"> 1. Turn main power disconnect switch to off position. 2. To open the lift cylinder holding valves located at the bottom of each cylinder: <ul style="list-style-type: none"> if higher reach required, use emergency lowering rod located on the top of the base to: <ul style="list-style-type: none"> (A) push (B) turn knurled knob counterclockwise. 3. To lower the platform, pull out emergency lowering valve located on the outside of the hydraulic tray.

No.	Label Pictorial	Description
27		<p>Serial Plate*</p> <p>Product identification and specifications *Serial plate will vary over different aerial platforms.</p>
28		<p>Hazard Identification</p> <p>Refer to Section 1: Safety Rules. Read and understand the outlined risks associated with this work platform prior to operation.</p>
29		<p>Emergency Main Power Disconnect</p> <p>Main power disconnect lever</p>
30		<p>Ground Circuit Breaker</p> <p>Push to reset ground circuit breaker.</p>
31		<p>Power Circuit Breaker</p> <p>Push to reset power circuit breaker.</p>
32		<p>Generator Circuit Breaker (If Equipped)</p> <p>Push to reset generator circuit breaker.</p>
33		<p>Connect Platform AC Supply</p> <p>Connect AC power supply here for platform accessory outlet.</p>

No.	Label Pictorial	Description
34		<p>Base Control Console</p> <p>Select “” to lower or “” raise platform.</p> <p>Select “” platform to enable platform controls, “” off to disable controls or “” base to enable base control console.</p> <p>Push “” to disable controls.</p>
35		<p>Winching/Towing/Pushing Procedure Refer to operating manual.</p> <ol style="list-style-type: none"> 1. Block or chock wheels to prevent aerial platform from rolling. 2. Turn main power disconnect switch to off position. 3. Locate brake valve, pump and lever. 4. Attach lever and push in black knob. 5. Pump lever 1-3 times. Brake is now released. 6. Push/tow/winch to desired location. 7. Block or chock wheels to prevent aerial platform from rolling. 8. Reengage brake by pulling out brake valve plunger. Remove brake lever and secure in clips.
36		<p>Forklift Pocket</p> <p>Insert fork fully into pocket to lift aerial platform.</p>
37		<p>Emergency Powered Extension Platform Retraction System</p> <p>Emergency Powered Extension Platform Retraction System</p>





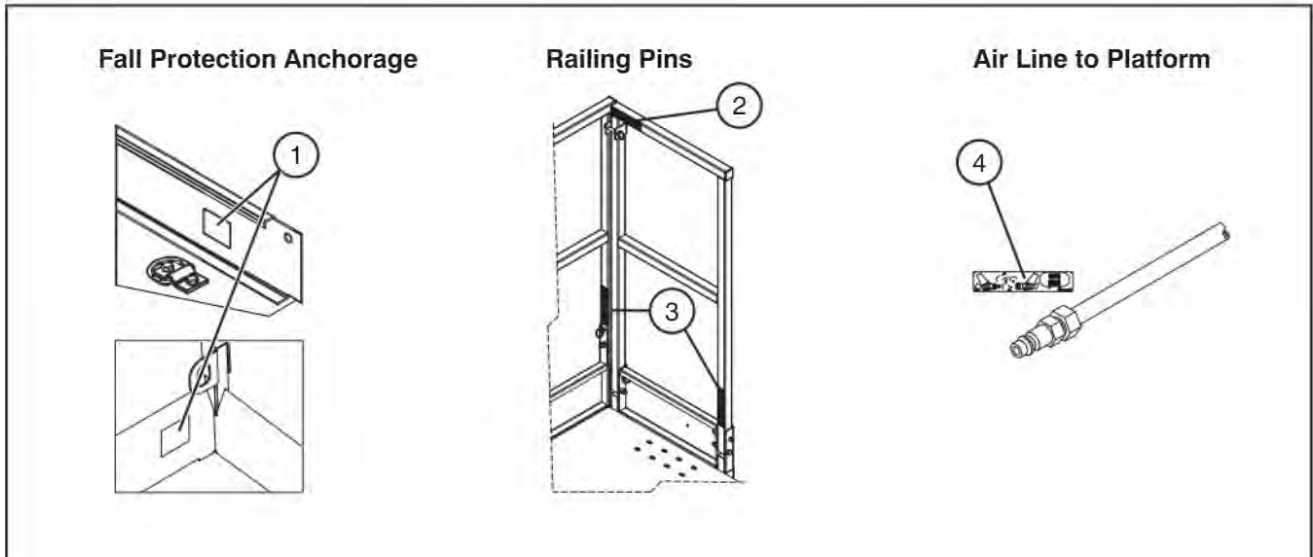



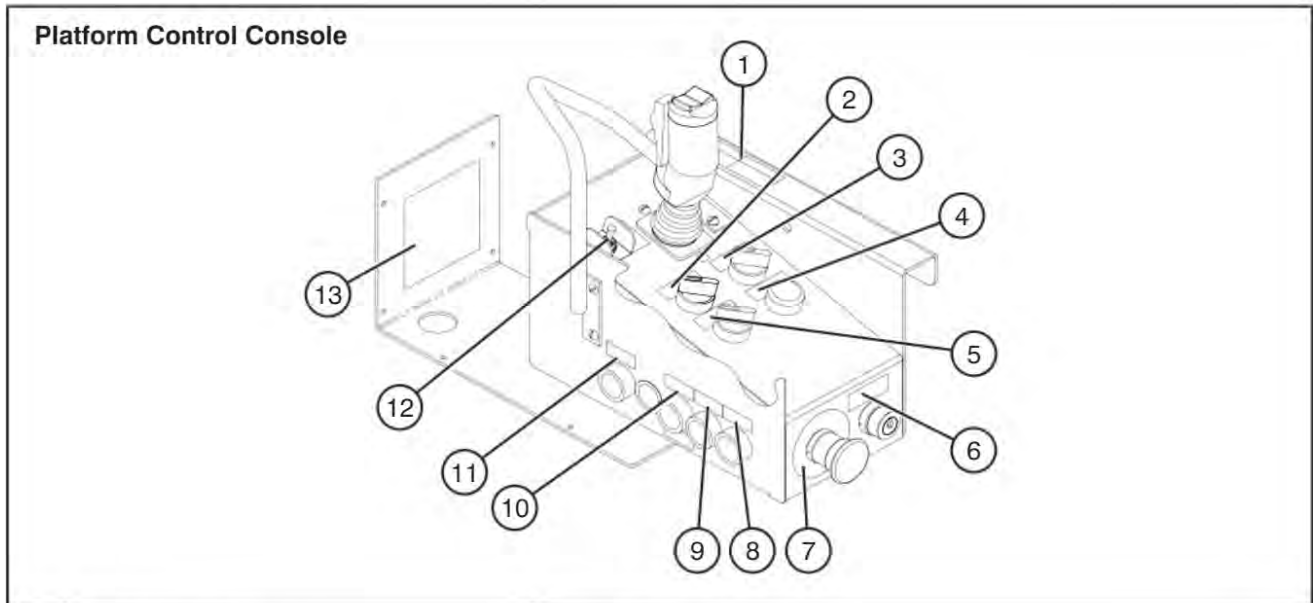

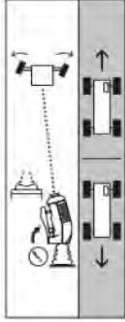



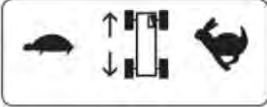















No.	Label Pictorial	Description
1		<p>Keep Clear</p> <p>Keep clear. Stay away from aerial platform when in operation.</p>
2		<p>Crushing Hazard</p> <p>Danger - crushing hazard</p>
3		<p>Warning - Do Not Alter</p> <p>Do not alter or disable limit switches or other safety devices.</p>
4		<p>Engine Control</p> <p>Select “” to start, “” run or “” stop engine.</p> <p>Select “” to energize glow plugs.</p> <p>Do not start engine “”. Red lamp “” illuminates until the glow plugs have completed the timed heating cycle. When the lamp goes out, the engine is ready to be started.</p>



No.	Label Pictorial	Description
1		<p>Fall Protection Anchorage</p> <p>Rated for one (1) person per anchorage.</p>
2		<p>Falling Hazard - Railing Pins (Horizontal) (If Equipped)</p> <p>WARNING! Falling Hazard. Make sure hinged railing is pinned properly.</p>
3		<p>Falling Hazard - Railing Pins (Vertical) (If Equipped)</p> <p>WARNING! Falling Hazard. Make sure hinged railing is pinned properly.</p>
4		<p>Connect Air Supply (If Equipped)</p> <p>Connect platform air supply here.</p>



No.	Label Pictorial	Description
1		<p>Controller Operation</p> <p>Squeeze “” trigger to enable controller.</p> <p>Operate “” rocker switch to steer.</p> <p>Move controller forward “” to drive forward or backward “” to drive reverse..</p>
2		<p>Low/High Speed Range</p> <p>Select “” for low speed (high torque) or “” high speed (low torque).</p>
3		<p>Low/High Throttle</p> <p>Select “” low or “” high engine speeds.</p>
4		<p>Power On/Overload Indicator</p> <p>Continuous illumination indicates upper control availability. Flashing indicates aerial platform is overloaded.</p>
5		<p>Raise/Off/Lower Platform</p> <p>Select “” to raise the platform, “” to turn power off or “” to lower the platform.</p>

No.	Label Pictorial	Description
6		<p>Lift/Off/Drive</p> <p>Select “” to enable lift, “” off or “” drive mode.</p>
7		<p>Emergency Stop</p> <p>Push to disable controls</p>
8		<p>Lift Enable</p> <p>Select to enable lift mode.</p>
9		<p>Start Engine</p> <p>Select to start engine.</p>
10		<p>Glow Plug</p> <p>Select to activate glow plugs.</p>
11		<p>Horn</p> <p>Select to sound horn.</p>
12		<p>Low/High Torque</p> <p>Select “” low speed (high torque) or “” high speed (low torque).</p>
13		<p>Controller Connector Pinout</p> <p>Controller connector pinout.</p>

Auxiliary Control Consoles

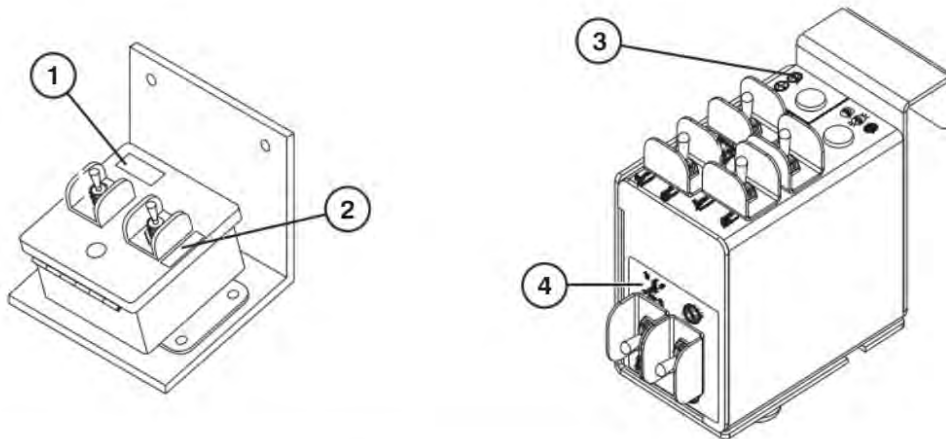

No.	Label Pictorial	Description
1		<p>Powered Extension Platform Enable</p> <p>Select to enable powered extension platform controls.</p>
2		<p>Powered Extension Platform Extend/Retract</p> <p>Select “” to extend or “” to retract powered extension platform.</p>
3		<p>Outrigger Controls with Generator</p> <p>Select “” to retract or “” to extend for each outrigger.</p> <p>Select “” to enable or “” disable generator.</p> <p>Indicates leveling system status:</p> <ul style="list-style-type: none"> Off: The outriggers are fully retracted. Flashing Rapidly: The outriggers are extending or retracting. Flashing: Not all outrigger legs have firm ground contact or aerial platform is not level. On: The outriggers are extended and the platform is level.
4		<p>Automatic Outrigger Controls</p> <p>Select “” to retract all outriggers or “” to extend all outriggers with automatic leveling.</p> <p>Select “” to enable manual or automatic outrigger controls.</p>

6.0 Skyjack Features

Your Skyjack machine may be equipped with the following features:



At the heart of every Skyjack machine, proven and simplistic control systems using Skyjack's colour coded and numbered wiring system make our machines the easiest to trouble shoot and repair. – Black #14 is for the lift function on a 3219, and it is lift on a 63AJ. Using an analog based control system allows Skyjack AWP's to operate using a simplified system with fewer and less expensive components – less maintenance and lower costs.



Skyjack's mechanical "axle based" drive system gives positive traction and excellent rough ground "terrain-ability". This industry leading terrain capability means one can use the Skyjack Rough Terrain Scissor Lifts, Boom Lifts and Telehandlers in the most challenging of conditions.



Having equipment with features and functionality that allow you and your customers to do more is a vital part of the utilization equation. Skyjack offers a range of accessory products to further expand a given products adaptability and your power to offer a truly flexible rental choice.

Notes

Lined area for notes with horizontal ruling lines.

SKYJACK™

www.skyjack.com